

INSTALLATION INSTRUCTIONS

HIGH CYCLE SPRINGLESS GRILLE SYSTEM

MODEL 600 HC

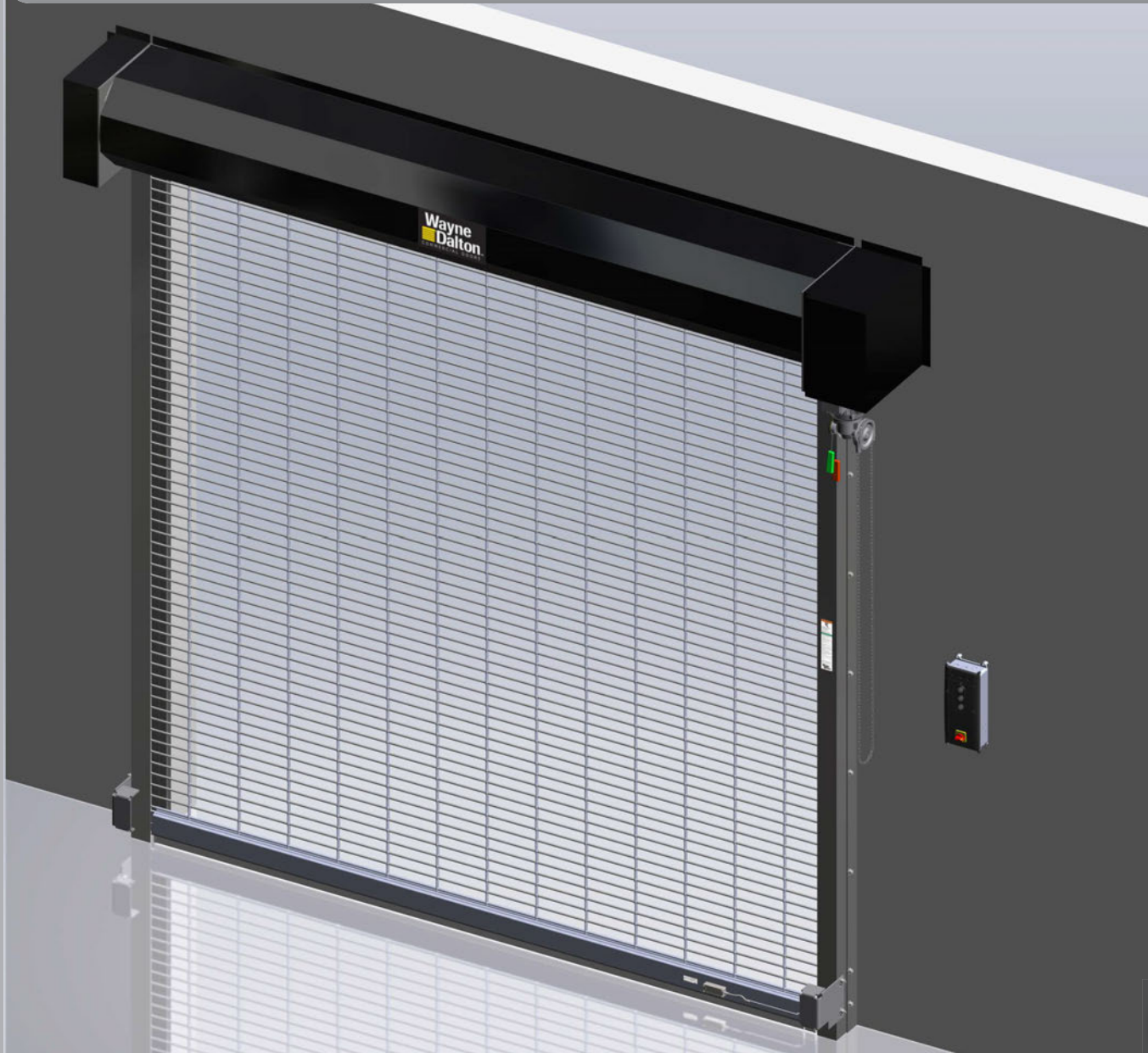

This installation manual provides the trained door technician information required to install, troubleshoot and maintain a High Cycle Springless Grille Door. **READ COMPLETE INSTRUCTIONS BEFORE INSTALLING DOOR.**

Some installation tasks listed in this document are found in other documents.

Please refer to the appropriate document(s) as directed;
308577 Hilti Kwik Bolt Installation
Found on Wayne-Dalton.com

Installation, repairs, and adjustments must be made by a trained door system technician using proper tools and instructions.

INSTALLER: Leave this manual with the end user!

End user: Note service and maintenance on page 31.



TABLE OF CONTENTS		
SECTION	CONTENTS	PAGES
1	SAFETY INFORMATION	3-4
2	HOW TO USE THIS MANUAL	5
3	GENERAL INFORMATION	6-8
4	INSTALLATION	9-23
5	HIGH VOLTAGE WIRING	24-26
6	CONTROLLER PROGRAMMING	27-30
7	SERVICE AND MAINTENANCE	31
	WARRANTY	32
	APPENDIX A - CONTROLLER MANUAL	3-67
	APPENDIX B - REFERENCE WIRING	68-70
	APPENDIX C - POWER CONSUMPTION CHART	71
	APPENDIX D - OPTIONAL WIRED SAFETY EDGE	72

NOTE: Advanced technical support is available at 1-800-764-1457 option 4.

SECTION 1 - SAFETY INFORMATION

OVERVIEW OF POTENTIAL HAZARDS READ THIS SAFETY INFORMATION

⚠ WARNING



Grille doors are large, heavy objects that move with the help of electric motors. Since moving objects and electric motors can cause injuries, your safety and the safety of others depends on you reading the information in this manual. If you have any questions or do not understand the information presented, you should consult a licensed professional.

In this section and those that follow, the words "**DANGER**", "**WARNING**", and "**CAUTION**" are used to stress important safety information. The word:

- ⚠ **DANGER** indicates an imminently hazardous situation which, if not avoided, will result in death or serious injury.
- ⚠ **WARNING** indicates a potentially hazardous situation which, if not avoided, could result in death or serious injury.
- ⚠ **CAUTION** indicates a potentially hazardous situation which, if not avoided, may result in injury or property damage.

The word **NOTE** is used to indicate important steps to be followed or important considerations.

1. Read manual and warnings carefully.
2. Keep the door in good working condition.
3. This door is equipped with photoeyes, check photoeye operation daily. Make any necessary repairs to keep it functional. Also check the function of any optional safety devices you have installed.
4. All models are equipped with an overcurrent device. This must be manually reset following an overcurrent condition.
5. Keep instructions in a prominent location near the Control Panel.

POTENTIAL HAZARD	EFFECT	PREVENTION
 <p>MOVING DOOR</p>	<p>⚠ WARNING Can Cause Serious Injury or Death</p>	<p>Do NOT operate unless the doorway is in sight and free of obstructions. Keep people clear of opening while door is moving.</p> <p>Do NOT change control to momentary contact unless an external reversing means is installed.</p> <p>Do NOT operate a door that jams.</p>
 <p>ELECTRICAL SHOCK</p>	<p>⚠ WARNING Can Cause Serious Injury or Death</p>	<p>Turn OFF electrical power before removing Control Panel or motor cover.</p> <p>When replacing Control Panel cover make sure wires are NOT pinched or near moving parts.</p> <p>Operator must be electrically grounded.</p>

SECTION 1 - SAFETY INFORMATION

Safety Instructions

Electrical Power Requirements for all High Cycle Springless Grille Door Models

All High Cycle Springless Grille Doors are available in single phase 220VAC or 3-phase 230VAC. 460VAC and 575 VAC input power is available with the use of a step-down transformer. **YOUR LOCAL CODES MAY REQUIRE THAT THE INCOMING POWER TO YOUR SPRINGLESS GRILLE DOOR HAVE A LOCK-OUT / TAG-OUT EQUIPPED FUSED DISCONNECT SWITCH (TO BE FURNISHED BY OTHERS) WITHIN EYESIGHT OF THE DOOR'S CONTROL PANEL.** Incoming power wiring must meet all NEC and local building codes, plus be properly sized for the control panel's amperage rating on the nameplate. To reduce the risk of electric shock, the chassis of the control panel must be properly grounded. Voltage at the door controller disconnect switch: 207-245v 3phase, 50/60HZ (230v systems) or 456-495v 3phase 50/60hz (460v systems). For 575v 3phase 50/60hz supply line, a step-down transformer must be installed to obtain 460v.

CAUTION

High Cycle Springless Grille Doors must be supplied by a properly grounded voltage supply, e.g. 220/240 VAC 1-phase or 208/230/460/575 VAC 3-phase. Floating (Open Delta) ungrounded voltage supply sources should not be used. For 480 VAC, 240 VAC or 120 VAC unbalanced Delta systems should **NOT** be used. Voltage unbalance is a common occurrence on Delta supply systems, which power both single phase and three phase loads, which can lead to unequal voltages on each phase leg. Voltage unbalance can cause deterioration of motor performance, such as loss of torque, overheating, decreases in the winding insulation life, and can cause motor starter contacts on the control panel to permanently "weld" closed. Voltage unbalance can be caused by inadequate conductor sizing, Delta transformer sizing, excessive single-phase loads, poor grounding, or intermittent high resistance faults which may cause destructive over-voltages to occur.

Wayne Dalton's warranty will not cover damage caused by failure of the motor, control panel or other electrical components due to the use of an inadequately grounded system.

Section 2 - How to Use This Manual

- **Section 1 - Safety Information**

Safety Information and Instructions. Important information related to safety terminology used throughout this manual. Safety related instructions must be followed at all times while performing any steps/tasks/instructions detailed in this manual.

- **Section 2 - How to Use This Manual**

This page.

- **Section 3 - General Information**

Details pre-installation issues that are recommended to be considered and/or resolved prior to beginning this door system installation.

The sections of this Installation Manual provide the information required to install, troubleshoot and maintain the Model 600HC High Cycle Springless Grille System.

WARNING

Failure to correctly perform all steps in Sections 4–6 can result in serious injury or death. Each section must be followed in step by step order to complete a successful installation.

- **Section 4 - Installation**

Provides step by step physical installation instructions for this product.

- **Section 5 - High Voltage Wiring**

Provides step by step high voltage wiring instructions for this product.

- **Section 6 - Controller Programming**

Provides step by step initial control set up and programming instructions for this product.

- **Section 7 - Service and Maintenance**

Provides related information on service and maintenance items.

- **Warranty**

- **Appendix - Controller Manual**

The controller manual provides additional instructions for wiring and programming of add on options, plus a section on fault codes.

Section 3 - General Information

Component Identification Drawing

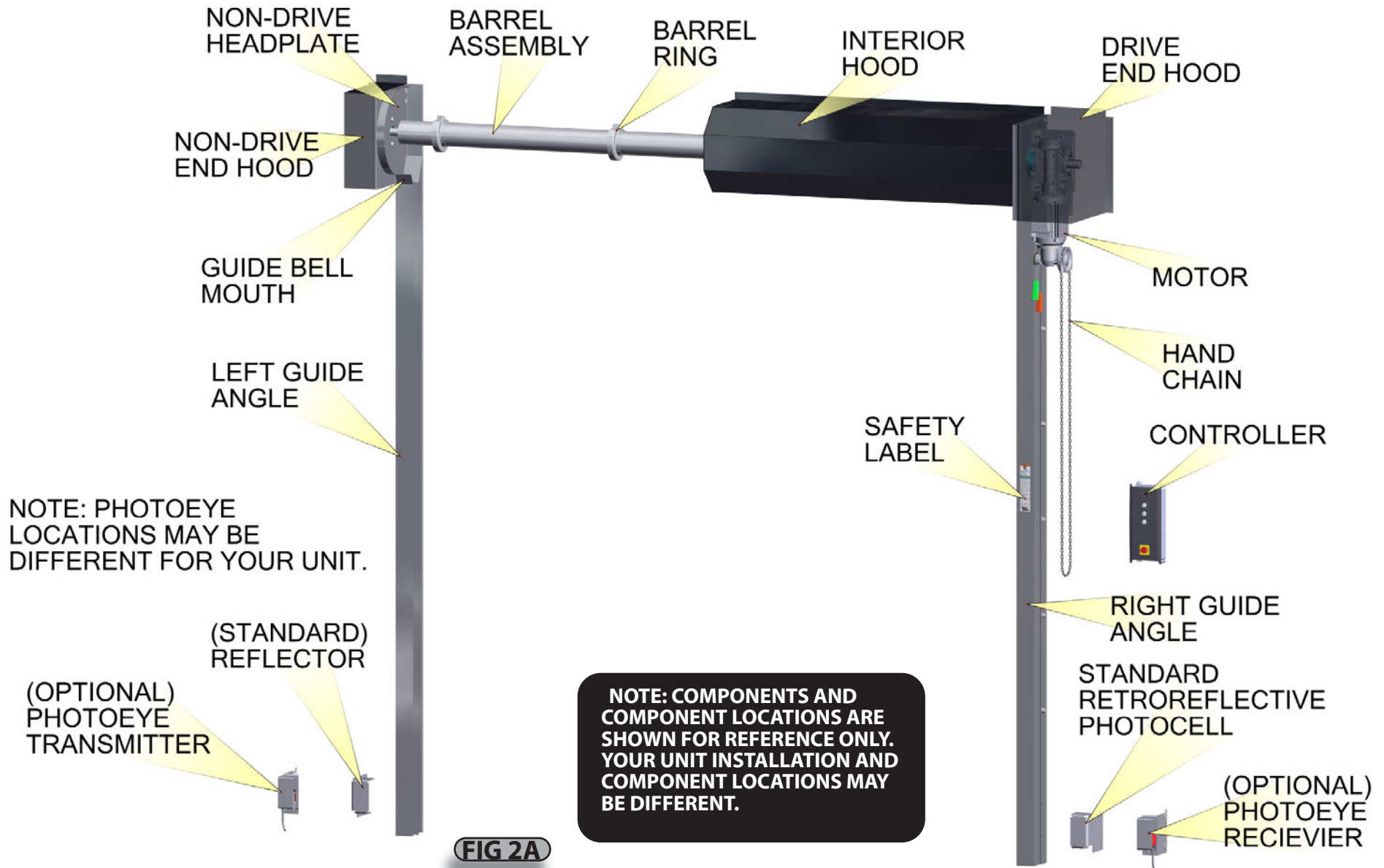

Section 3 - General Information

Job Site Issues/Considerations

The following list of items should be considered prior to installing your Springless Grille Door.

- Verify the opening measurements, head room, and side room required for this installation.
- Type of door jamb.
- Availability of a power supply, which side of door it is on, and the line voltage.
- Door system mounting environment. Items to consider include operator location, dampness of location, dustiness of the location and corrosiveness of the location.
- Door activation needs and requirements. Examples include 3 button control stations, 1 button control stations, radio controls, loop detectors, photoeyes, key switches, motion detectors, etc.
- Accessory equipment needs and requirements. Examples include sirens, warning lights, etc.

Entrapment Protection

Photoeyes are required for all Springless Grille Doors. Photoeyes are standard with these models. Do **NOT** disable them.

Door Specifications

DOOR MODEL NUMBER (circle one):	600HC
OPENING WIDTH:	
OPENING HEIGHT:	
MOTOR MOUNTING: (check one)	<input type="checkbox"/> INTERIOR or <input type="checkbox"/> EXTERIOR <input type="checkbox"/> LEFT HAND or <input type="checkbox"/> RIGHT HAND
CURTAIN COLOR:	
OPERATOR: HP _____	RATIO _____
OPERATOR VOLTAGE:	
"S" DIMENSION _____	"G" DIMENSION _____
HEADROOM REQUIREMENT:	
SIDE ROOM: DRIVE _____	NON-DRIVE: _____
GUIDE GAP _____	GUIDE TYPE _____
CURTAIN WEIGHT: _____	



Installation Data

NAME PLATE SERIAL NUMBER:
JOB NAME:
DISTRIBUTOR:

NOTE: The ID plate is located on the bottom bar.

Section 3 - General Information

SHOP DRAWING

1 SHOP DRAWING

- A. Your shop drawing should be found inside the door hardware bag. You will need to refer to the data on this drawing during installation. Record the pertinent data on page 7 of this manual as a backup.
- B. Verify that the "Factory Order Number" on the door components matches the one shown on the shop drawing.

2 PRE-INSTALLATION CHECK LIST

Ensure the door installation can be accomplished before proceeding.

- Check that the wall opening, **Fig. 3-B**, matches the Opening Width and Height shown on the shop drawing.
- Check that the sill is level and plumb.
- Verify the guides you received are suitable for the jambs. Compare the guide type on the shop drawing with **Fig. 3-C**.

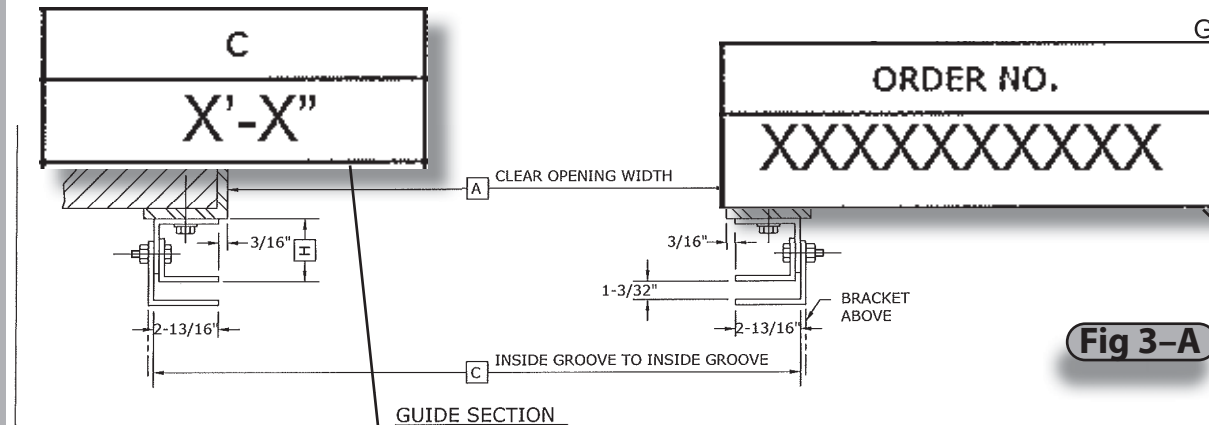
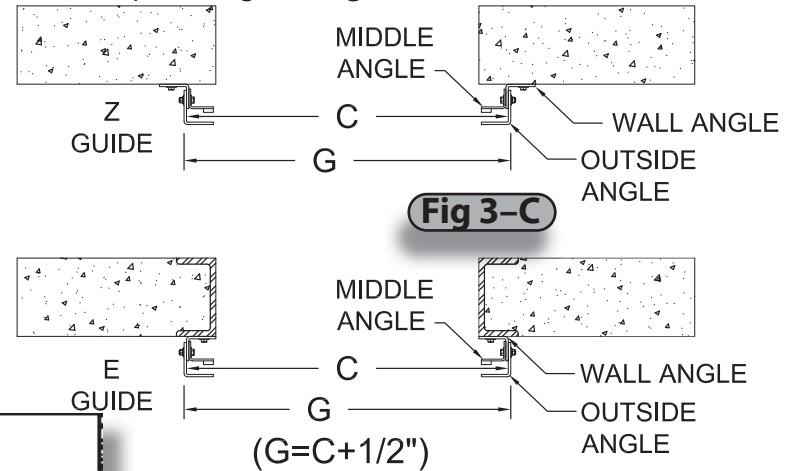
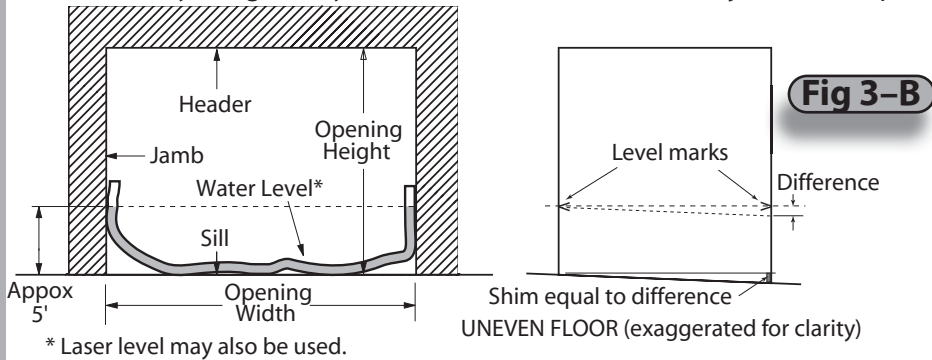

NOTE: WIDTH C IS IMPORTANT AND MUST BE HELD

DOOR QTY.	ITEM NO.	HAND OF OPER.	CUST. OPG. NO.	WIDTHS			HEIGHTS			GUIDE		FOR BRACKET		SLAT LENGTH
				A	C	E	B	D	F	H	X	Y		
					X'-X''									

Wayne Dalton
a Division of Overhead Door Corporation

Rolling Door Division
Kamco
North American

ADV ROLLING DOOR MODEL :
PROJECT :

ARCH :
G.C. :
DISTR :

DISTR P.O. NO. : PREPARED BY : DATE :

REVISION ORDER NO. DWG. NO.
XXXXXXXXXX OF

Section 4 - Installation

STEP 1 INSTALL GUIDE WALL ANGLES

NOTE: It is only necessary to disassemble the guides for screw attachment of "E" type guides. Welded "E" assemblies and all "Z" assemblies may be installed as assembled from the factory.

- A.** Remove the middle angles and outside angles from the guide wall angles. (Perform this for "E" non-welded guides only.)
- B.** Mount guide wall angles to achieve the "S" dimension (on the Installation Data Sheet) plus 1/2" as shown in the illustration on the previous page **FIG 3C**. (The extra 1/2" allows for the thickness of the outside angle.)
 - The "G" ("S" + 1/2") dimension must be held within 1/8" over the entire height of the wall angle.
 - The guides must be on a level plane and plumb.
 - Place shims under the wall angle on the tall side of the opening if necessary to put them on level, **FIG 3B**.
 - Check plumb with a level or plumb bob.

STEP 2 MOUNTING METHODS

The following instructions use the Z-Guide positioning for the wall angles, use the Z-Guide or E-Guide positioning best suited for your site.

Masonry Jamb

- Hold Z-Guide wall angle against the wall and drill mounting holes through the slots using drill size shown in **TABLE 4A**. Install jamb fasteners (**TABLE 4A**) on one wall angle. Install second wall angle at "G" distance, refer to **FIG 3C** on the previous page. Check for level and plumb. Use spacers between Guide and wall as needed for plumb.

Steel Jamb

Steel jamba (welded or screwed) use "E" guides, all others use "Z".

- **SCREW ATTACHMENT OPTION**
 - Hold E-Guide wall angle against the jamb and drill holes through the slots using drill size shown in **TABLE 4A**. Install all jamb fasteners (**TABLE 4A**) on one wall angle, then install second wall angle at "G" ("S" + 1/2") (**FIG 3C**) distance. Check for level and plumb.
- **WELD ATTACHMENT OPTION**
 - Hold E-Guide wall angle against the jamb and tack weld in place. Install second wall angle at "G" ("S" + 1/2") (**FIG 3C**) distance. Check for level and plumb. Apply welds as shown in **FIG 4B**, using welding electrodes E6010, E6011 or E7014.

JAMB	FASTENER	DRILL SIZE	JAMB FASTENER SPECIFICATIONS
Steel	1/2" self-tapping screw	27/64" diameter	Steel jamba must be minimum 3/8" thick
Concrete	1/2" wedge anchor	1/2" diameter	Drill hole at least 4" from jamb corner per OHD Installation Instruction 308577 available on odcexchange.com .
Filled block	1/2" wedge anchor	1/2" diameter	Drill hole at least 4" from jamb corner per OHD Installation Instruction 308577 available on odcexchange.com .
Wood	1/2" lag screw	3/8" diameter	Drill hole 3" deep
Unfilled block	1/2" thru bolt	9/16" diameter	Install 3" O.D. steel washer on opposite side of wall.

TABLE 4A

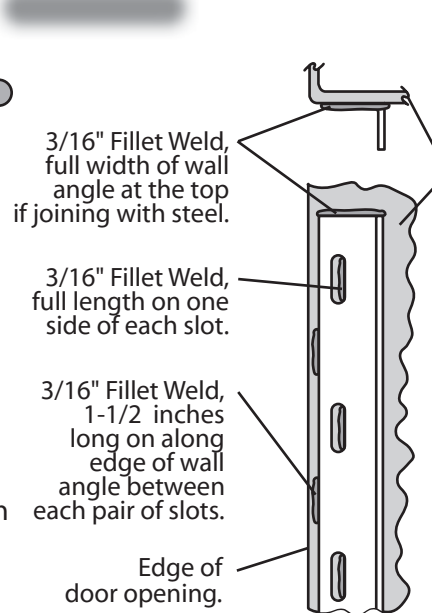

FIG 4B

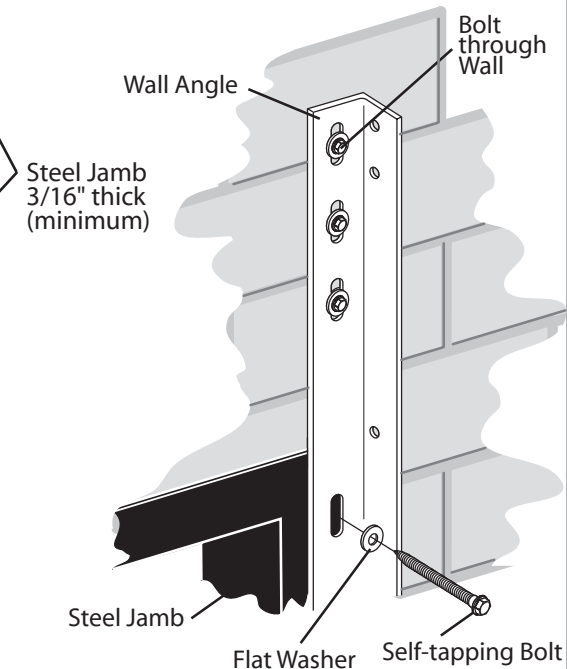

FIG 4C

NOTE: When the wall angle extends above the steel of the jamb or header, use washers, spacers or shims to fill the gap between the masonry portion of the wall and the wall angle. Use through bolts to fasten the wall angle in the area above steel, **FIG 4C**.

Section 4 - Installation

STEP 3 IDENTIFY HEADPLATE BRACKETS FIG 4D

Right hand drive is shown (left hand drive opposite).

STEP 4 IDENTIFY DRIVE END OF BARREL ASSEMBLY FIG 4D

Right hand drive is shown (left hand drive opposite). The **drive end** of barrel assembly typically is longer and is keyed. **FIG 4D**

STEP 5 ASSEMBLE BARREL AND HEADPLATE BRACKETS FIG 4D

- Slide the drive headplate bracket and bearing onto drive end of the barrel shaft (longer shaft).
- Slide the non-drive headplate bracket and bearing onto the non-drive end of the barrel shaft (short shaft).
- Slide one set collar onto the drive end and another set collar onto the non-drive end of the barrel assembly.
- Lightly tighten the set screws on the set collars.
- The distance between the outside of the headplate brackets should be less than the "S" dimension, **FIG 3C Page 8**.
- Do **NOT** tighten bearing or set collar set screws at this time.

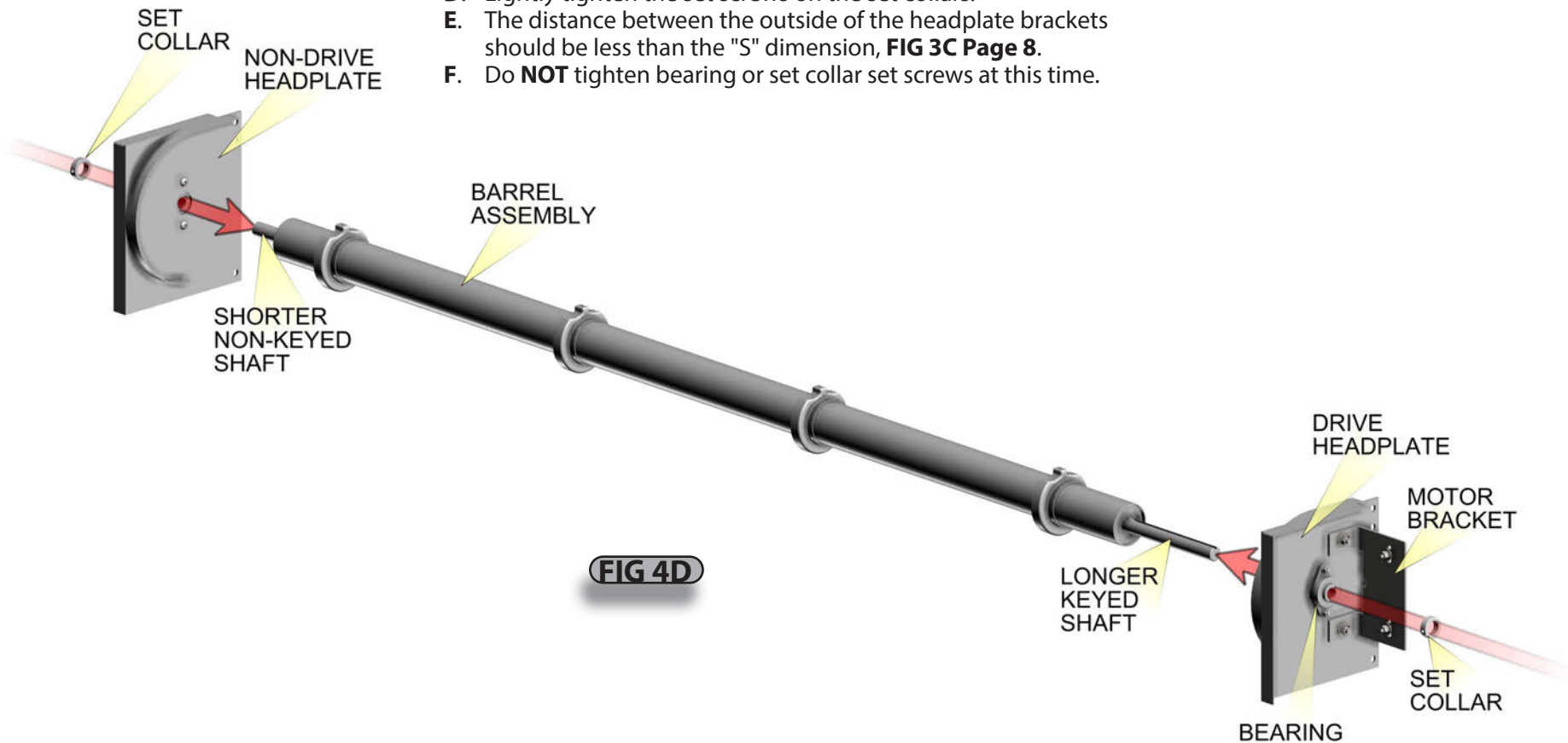

Section 4 - Installation

CAUTION

Use proper lifting equipment and correct lifting procedures to avoid injury.

STEP 7 MOUNT BRACKETS AND BARREL ASSEMBLY, FIG 4E

- A. Headplate brackets must be square to the wall and parallel.
- B. Use hex bolts, nuts and washers (provided) to fasten headplate brackets to the outside of the wall angles. Use washers under both the bolt head and nut.
- C. Bolt heads must be on the inside of the headplate brackets.
- D. Use a level to **make sure the barrel is level**.
- E. Position the barrel assembly such that the curtain, mounted on the barrel, will be centered between the headplates, **FIG 4F**.

CAUTION

A level barrel is crucial to the correct operation of the curtain. If the barrel is NOT level, the curtain will begin to "telescope" towards the low end and may damage the curtain.

- F. Tighten bracket bearing set screws on both headplates to prevent barrel from sliding side to side.
- G. Slide set collars against headplate bearings and tighten set screw on the set collars.

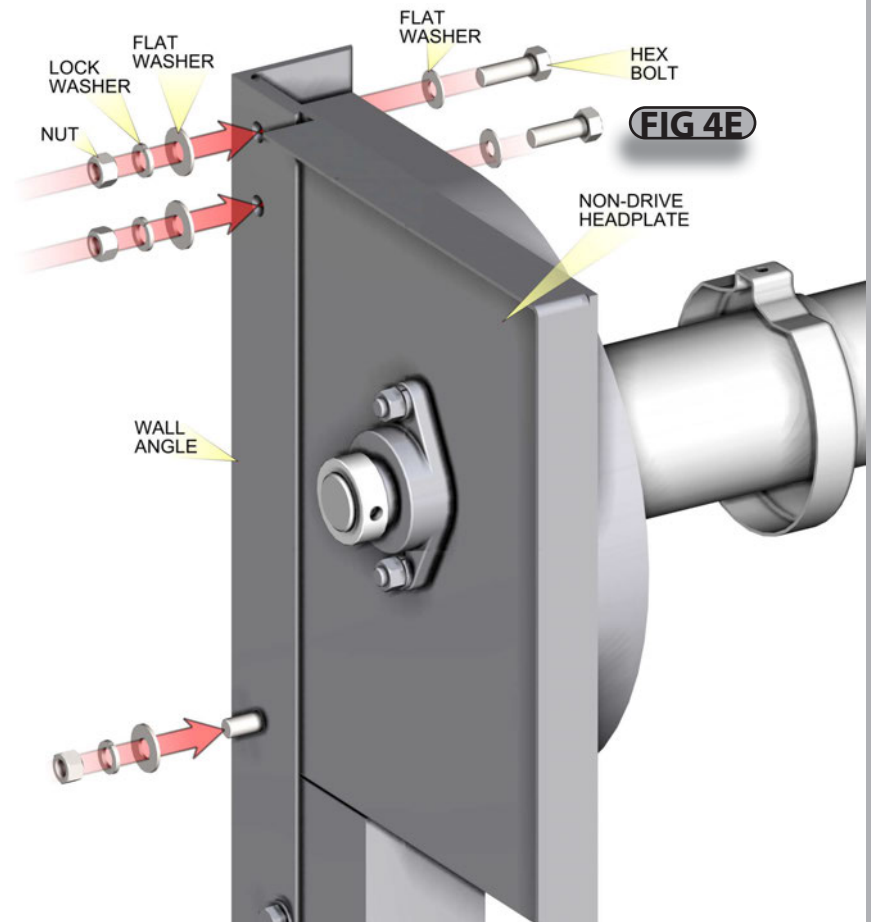
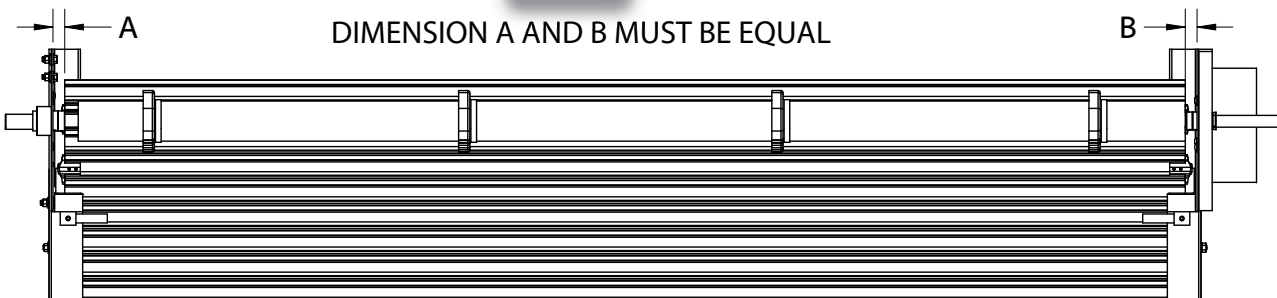

FIG 4F



Section 4 - Installation

STEP 8 INSTALL MOTOR

- A. Remove motor mounting hardware from the motor bracket **FIG 4G**.
- B. Loosen (but do not remove) the hardware holding the motor bracket to the headplate.
- C. Slide the motor onto the shaft and reinstall the mounting hardware. **FIG 4G**
- D. Tighten the motor bracket hardware loosened in a previous step.
- E. Manually turn the shaft as needed to align the keyway of the motor with the keyway of the shaft. Install the key.

⚠ WARNING

Do NOT connect power at this time. Power must be routed through the controller that will be mounted in a later step. Connecting Mains power directly to the motor will result in uncontrolled operation with possible serious injury or death.

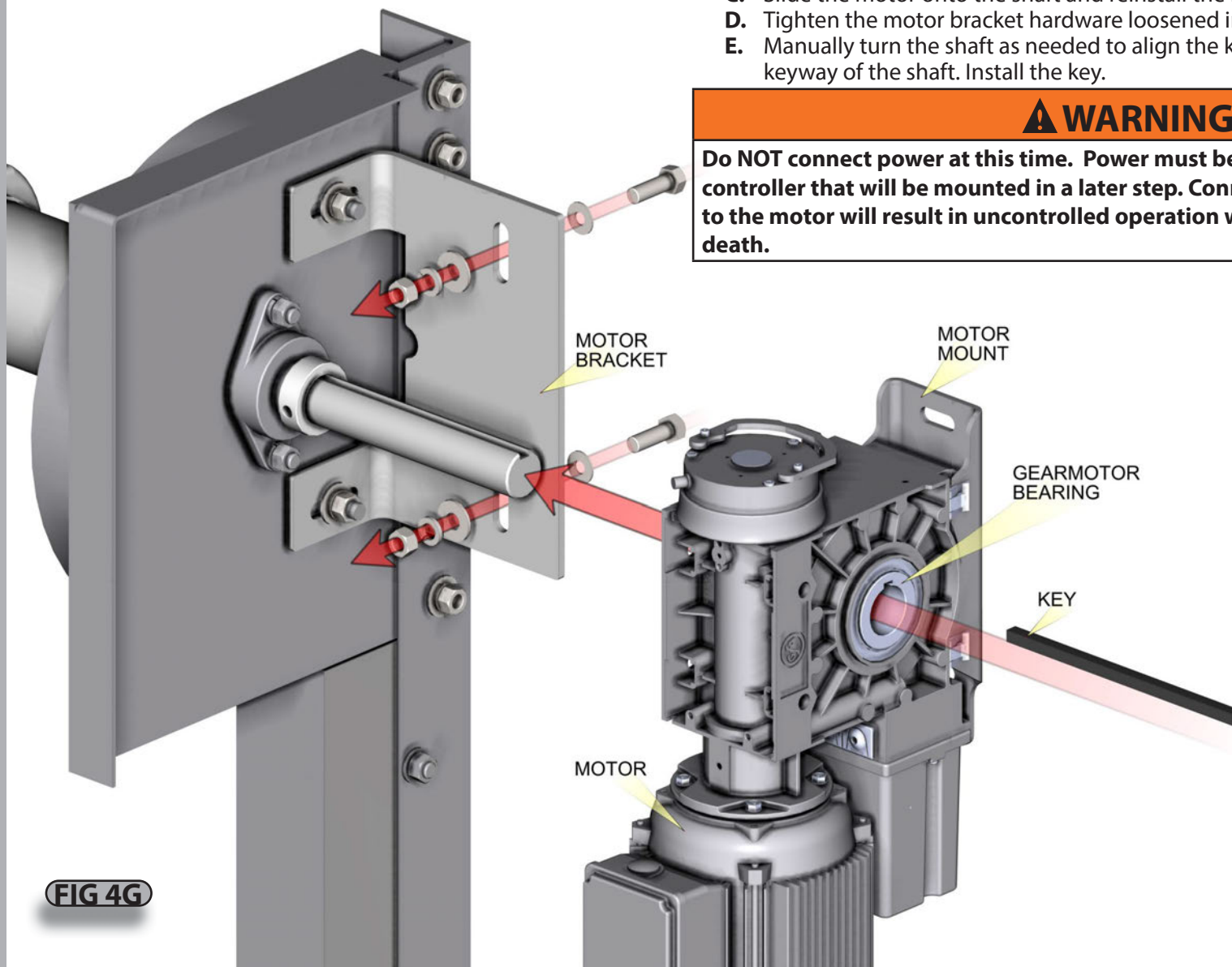

FIG 4G

Section 4 - Installation

STEP 9 INSTALL CURTAIN ONTO BARREL

NOTE: If guide angles are already installed, cover the bell mouth opening of the guide angles to protect the curtain from being scratched or damaged during these steps.

- A. Pull the red manual operation cord on the motor (**FIG 4I**) and use the hand chain to rotate the barrel assembly so that the bolt holes or studs on the barrel rings are facing up. Different barrel assembly lengths will have more or less rings/studs, **FIG 4J(a)** and **Fig 4J(b)** on page 14.
- B. Suspend the curtain below the barrel on two or three slings or ropes rated for the weight of the curtain, **FIG 4H**. (Refer to your Installation Data Sheet.)

⚠ WARNING

Ensure the slings/ropes are securely fastened as they will temporarily support the weight of the curtain. Improper use of slings /ropes could result in the unsecured curtain falling which could cause severe injury or death.

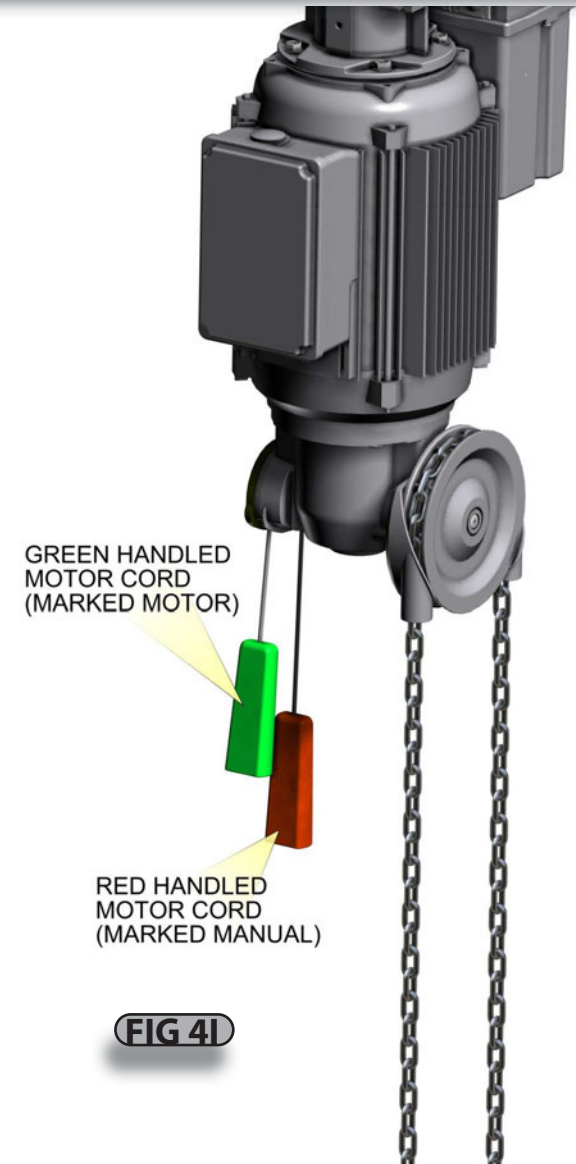
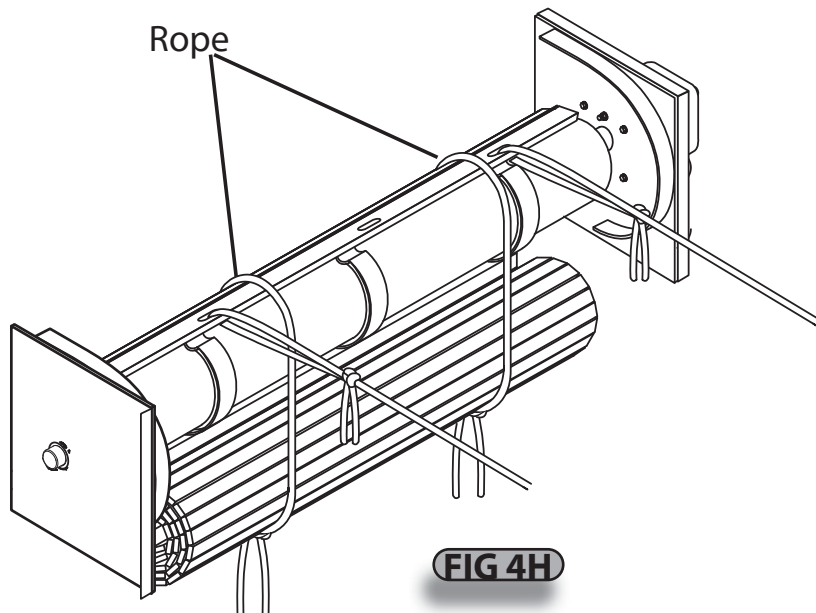

Section 4 - Installation

- C. Center the curtain between the headplate brackets and pull the top slat up and over the back side of the barrel.
- On small doors, the curtain can be rotated by hand.
 - On large doors attach the top slat to two slings/ropes and rotate the slings/ropes to bring the top slat into position.
- If the barrel has rings,
- Pull the curtain up and hold top slat against the rings, **FIG 4J(a)**.
 - Align the slots in the top slat with the holes in the rings.
 - Fasten the curtain to the rings with 3/8-16 x 5/8" Torx head screw and washers provided.

⚠ CAUTION

Take care to prevent stripping threads. Stripping could result in the need to replace the barrel rings.

If the barrel has studs,

- Pull the curtain up and hook the slots in the top slat over the studs.
 - Fasten at each stud with a 1/4-20 x 3/4" round head screw, flat washer, and two clamp washers (provided), **FIG 4J(b)**.
- D. Coil the curtain completely onto the barrel using the hand chain.
E. Feed safety edge and curtain into bellmouth of guide.
F. Using the hand chain, lower curtain into guides.
G. Install provided bottom bar stops.

⚠ WARNING

Do NOT remove the slings or ropes at this time. If slings or ropes are removed at this point the curtain could unroll rapidly causing sever injury or death.

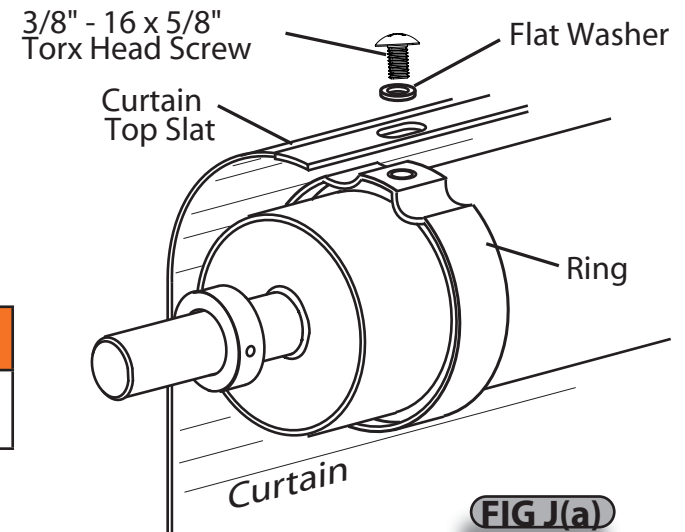

FIG J(a)

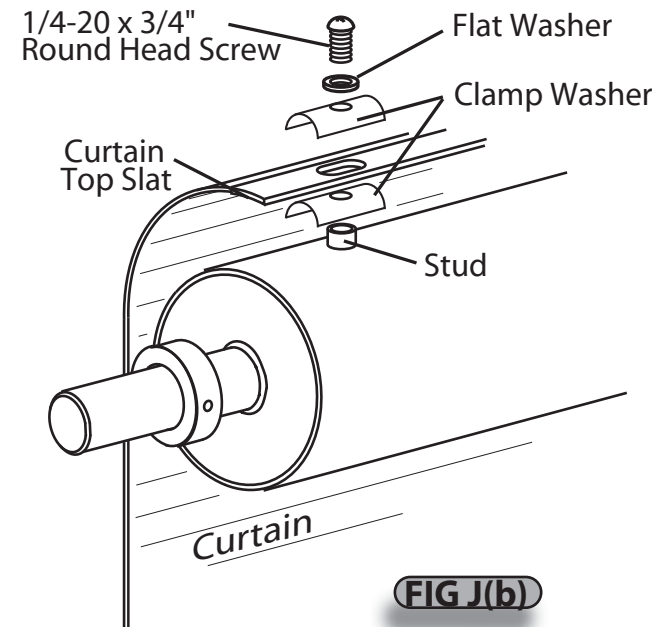

FIG J(b)

Section 4 - Installation

NOTE: If you have welded "E" assemblies or "Z" assemblies factory assembled and have already installed them in a previous step, skip Step 10.

STEP 10 INSTALL GUIDE ANGLES

Bolt the middle angles and outer angles to the wall angles as shown in **FIG 4K**. (Wall angles may be mounted inside or outside based on installation requirements, **FIG 4L**.)

- The "Guide Gap" **MUST** be set to the value given on the Installation Data Sheet. Refer also to Door Specifications on page 7.

STEP 11 RELEASE THE CURTAIN

- Pull the green motor cord to re-engage the motor and brake.
- Remove the slings or ropes. The curtain is now held in place by the motor brake.

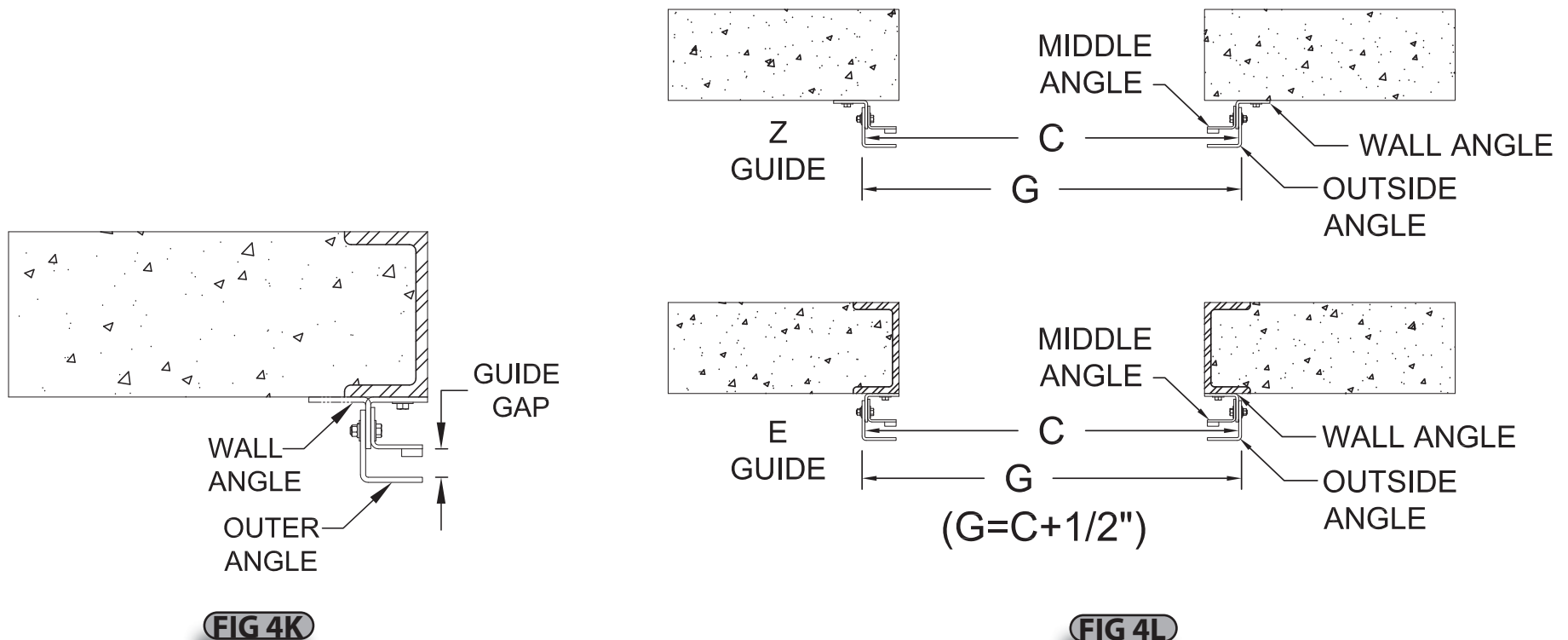

Section 4 - Installation

NOTE: LINE POWER should NOT be installed at this time. In the following steps electrical components will be physically mounted.

⚠ DANGER

Ensure that all incoming power supplies have been de-energized prior to beginning work on attachment of your Springless Grille Door electrical control systems. Use proper Lock Out/Tag Out procedures. **Do NOT connect components to electrical supply until directed to do so. Attempting to wire this system hot could result in serious injury or death.**

STEP 12 MOUNTING AND CONNECTING/WIRING STANDARD ELECTRICAL COMPONENTS

This step encompasses the installation and wiring of several components;

- Step down transformer (if required),
- Control Panel,
- Photoeye

A. If your building supply voltage is 575VAC or 460VAC you will need to install the step down transformer, see chart below. (If your building supply voltage is 230VAC you can skip part A and start with part B).

Find a suitable and easily accessible location for the step down transformer.

- Locate step down transformer on the wall near the motor. Verify that the door on the enclosure can open in the selected location.
- Away from heat sources.
- With no interference of moving parts of the door system.
- Where cables can be well secured while preventing unnecessary strain.
- Use the step down transformers interior mounting holes to mount to the wall. (Fasteners not provided.)

B. Find a suitable and easily accessible location for the Control Panel, FIG 4M.

- Adjacent to the door, on the wall, about 5 feet above the floor at the center of the panel (roughly eye level). It may be mounted higher in retail applications to reduce tampering.
- Where all moving parts of the door system are visible while at the control panel.
- Away from heat sources.
- With no interference of moving parts of the door system.
- Where cables can be well secured while preventing unnecessary strain.
- Mount the Control Panel to the wall. (Fasteners not provided.)

STEP DOWN	PART NUMBER
575VAC => 230VAC	500207-0003
460VAC => 230VAC	500207-0002

NOTE: Use fasteners appropriate for wall type.

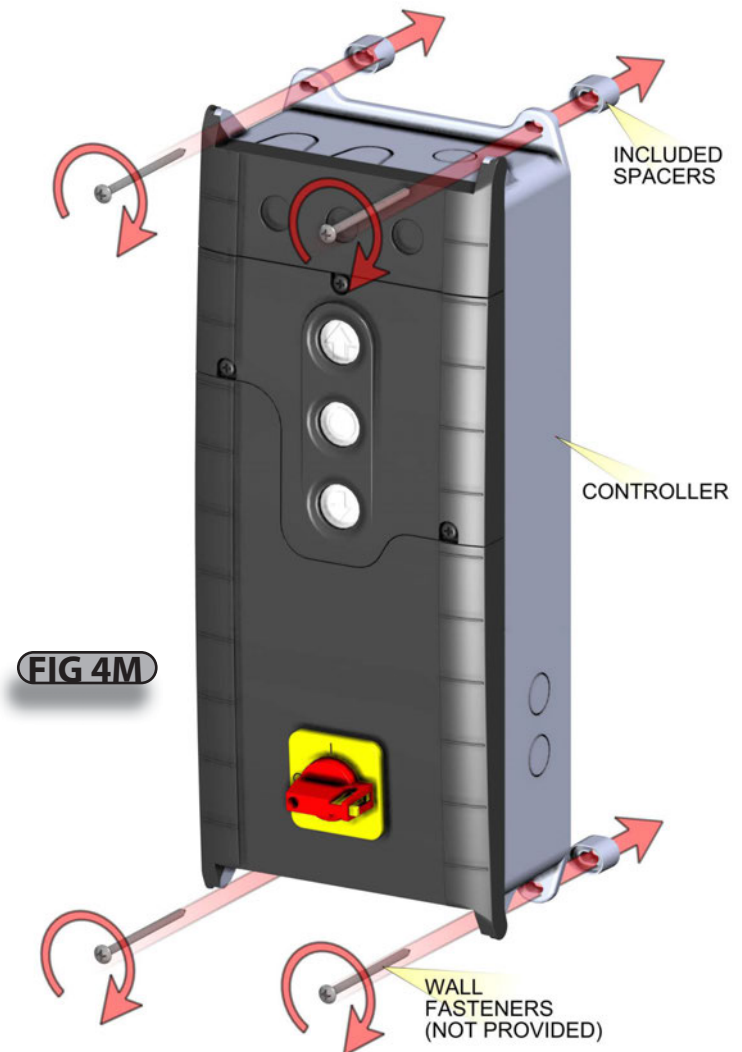

Section 4 - Installation

NOTE: To meet UL 325 code the High Cycle Springless Grille Door will need a monitored safety device. The controller can only monitor one safety device. The photoeyes that come with this package can be used as the monitored safety device by following FIG 40. If you are using the optional sensing edge then you will need to connect the photoeyes according to FIG 4P. The optional sensing edge will use the monitored port (2.1-2.5) and the photoeyes will be non monitored.

STEP 12 MOUNTING AND CONNECTING/WIRING STANDARD ELECTRICAL COMPONENTS (Continued....)

D. Photoeye assemblies are factory mounted to their protective shields. Attach to guides as follows, **FIG 4N**.

1. Mount Retroreflective photoeye or optional photoeye receiver (prewired cable) to the lowest guide assembly bolt (Drive / controller side) such that the Photoeye is aimed to the opposite guide. Route the cable up and plug into the controller. See **FIG 40** (monitored), **or FIG 4P** (non monitored).
2. Mount the photoeye reflector or optional photoeye transmitter to the lowest guide assembly bolt on the opposite guide directly across from the photoeye / receiver. (Optional thru beam only) Route the wire up the guide and over the controller and connect as shown in **FIG 40** (monitored), **or FIG 4P** (non monitored).
3. Photoeyes will be aligned later, when power is applied to the Control Panel. See page 30 Photoeye Adjustment.

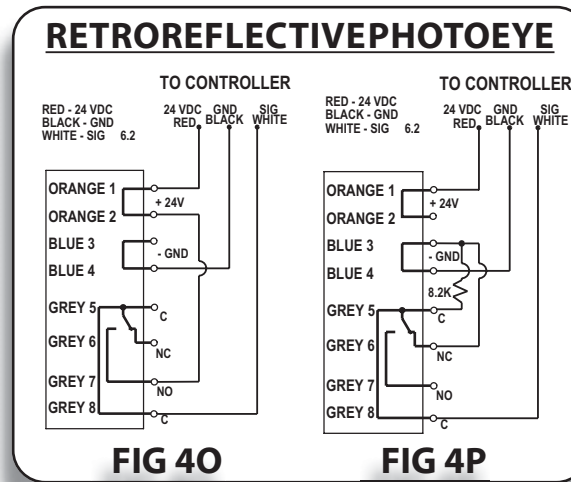
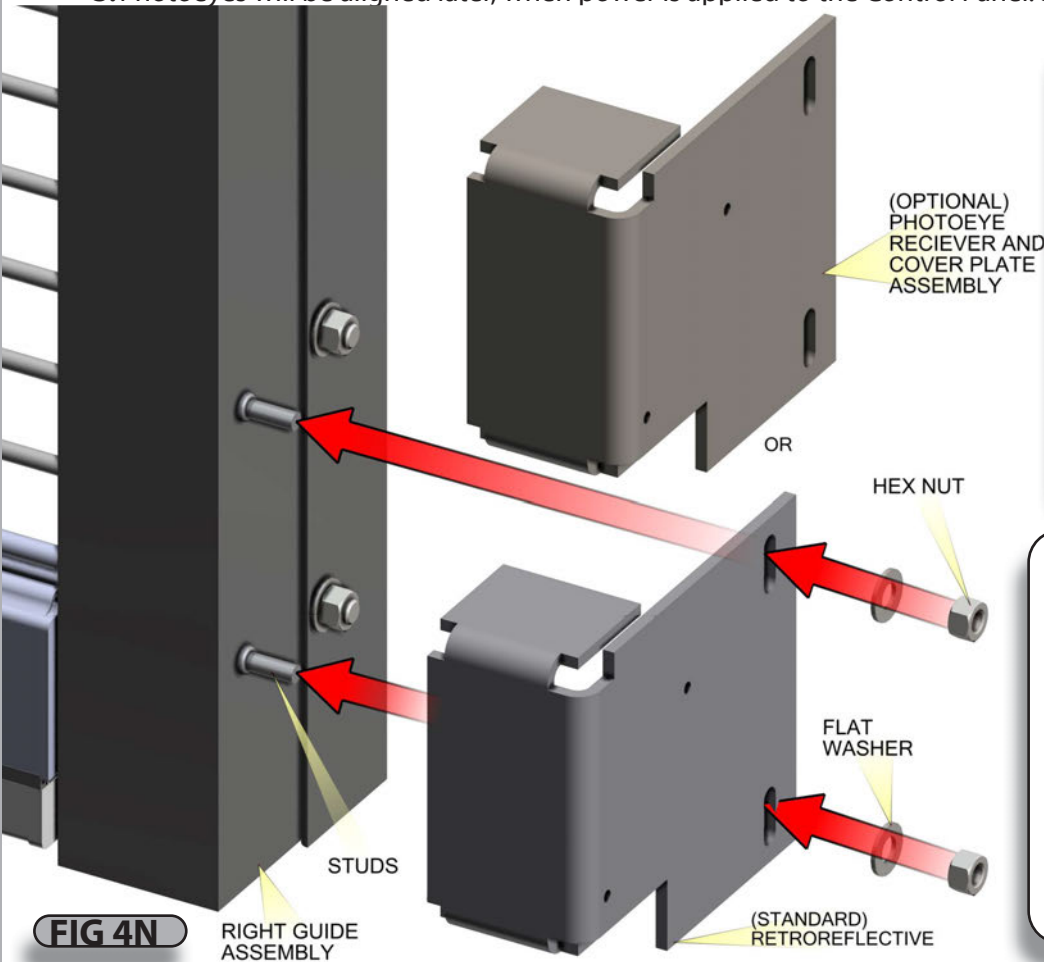

NOTE: For parking garage applications photoeyes may be mounted higher to prevent the beam from shooting beneath vehicles.

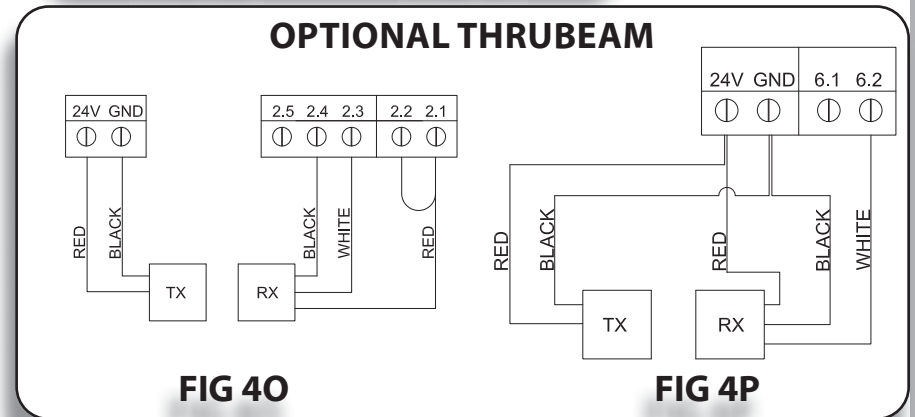

Section 4 - Installation

STEP 13 WIRING OF ADDITIONAL SAFETY DEVICES

A. Connect additional safety devices as applicable. See appendix for wiring diagrams.

STEP 14 CONNECT MOTOR CABLE AND ENCODER CABLE

- Use the two knockouts closest to the front of the control panel for the motor and encoder cables.
- Run the cables through the knockouts using the supplied cable glands.
- Run the cables into the control panel and up the channel on the left side as shown in FIG 4Q.
- Connect the cables to the ports in the top of the control panel as shown in FIG 4R.



FIG 4R

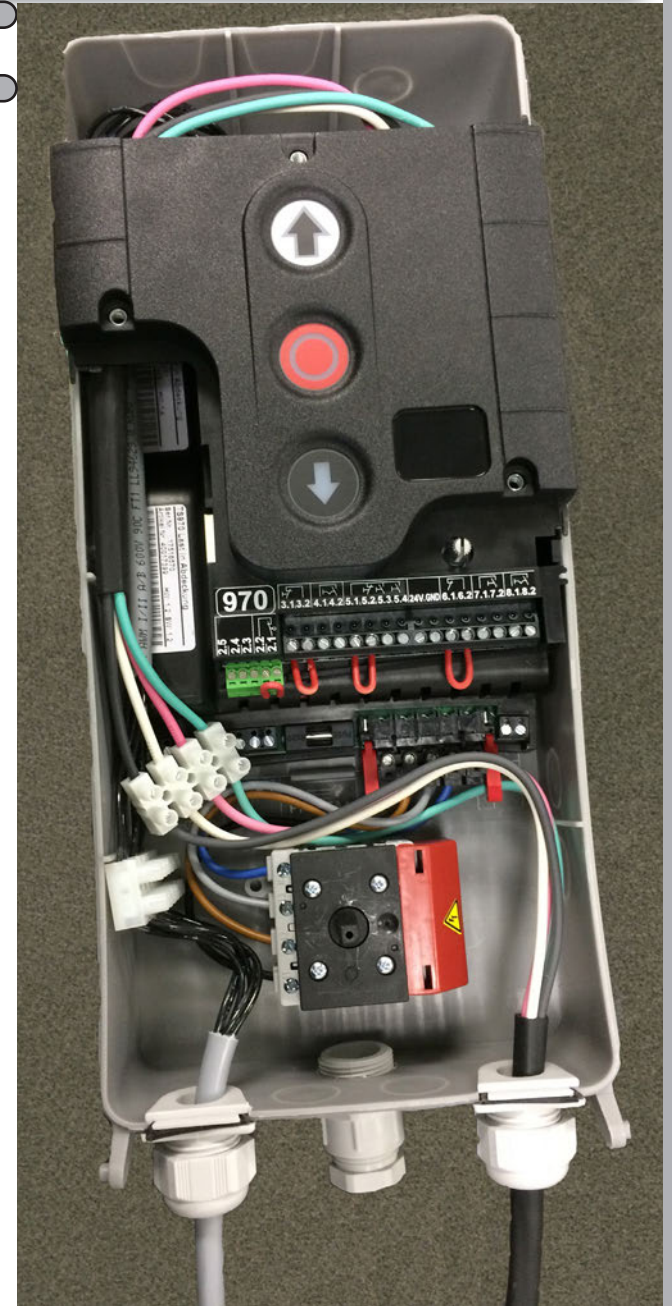

FIG 4Q

Section 4 - Installation

STEP 15 INSTALL SAFETY LABELS

Product safety labels must be installed.

- A. Find Safety Labels in hardware box.
- B. Attach **Sensing edge** Safety Label to the bottom bar (if equipped).
- C. Place main Safety Label at a readable height on door drive side guide or jamb.

NOTE: Product safety labels should be periodically inspected and cleaned by the product user as necessary to maintain good legibility. Order replacement safety labels from the door manufacturer as required to maintain legibility.

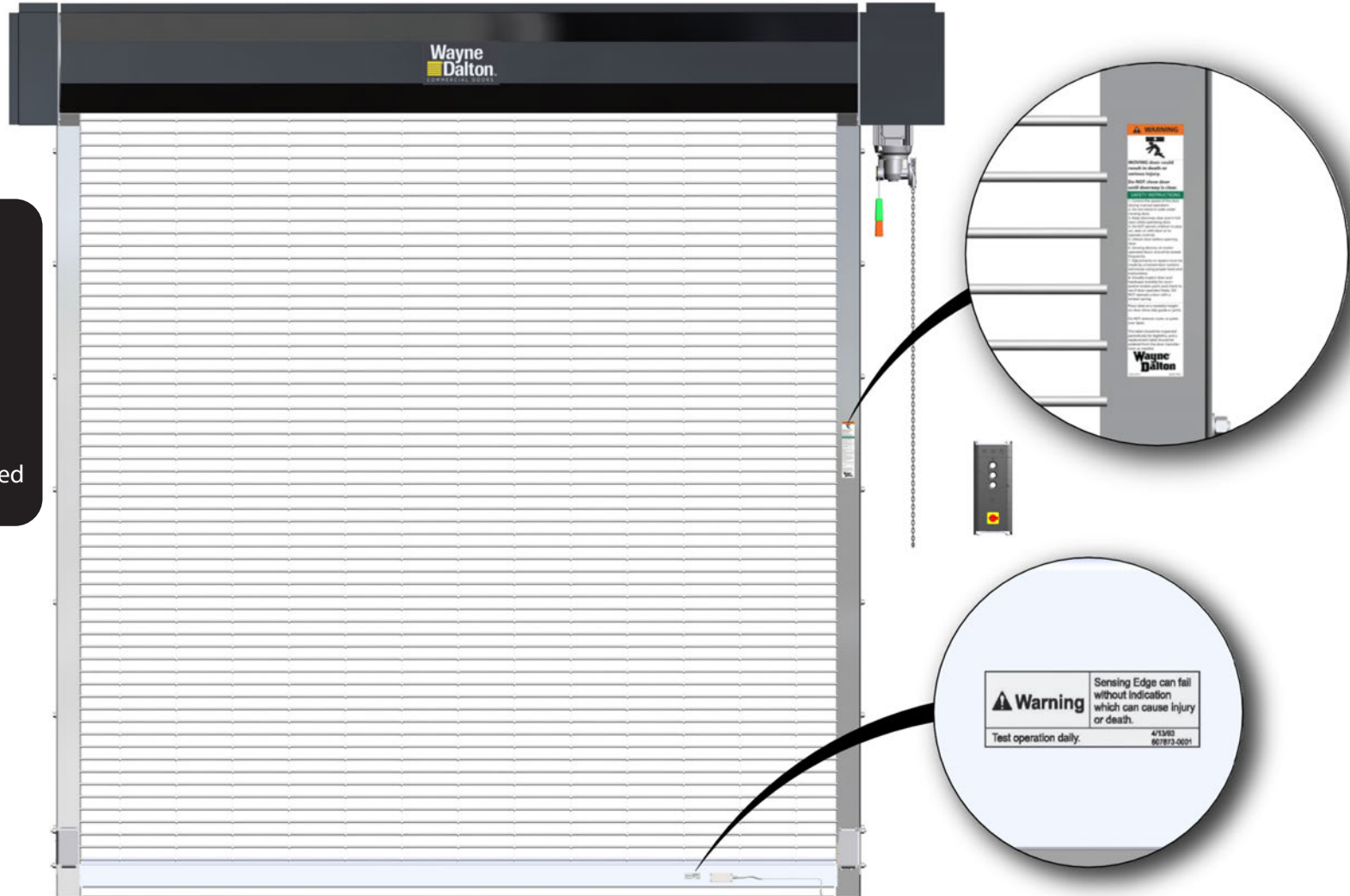

FIG 4S

Section 4 - Installation

STEP 16 PRE HOOD CHECKLIST

- A. Operate the door manually several times. Make sure the endlocks or windlocks are not rubbing endplates through the entire travel of door.
- B. Check that the bottom bar is level at top and bottom and the curtain is not binding against the back of the guides.
 - If curtain is level at bottom but not at top, place shims between the curtain and barrel on the low side.
- C. Verify good mechanical connection and tightness of fasteners, i.e., guides, headplates, set screws.
- D. Position the door at the half open position.

Section 4 - Installation

STEP 17 LEVEL DOOR (IF NEEDED)

If during previous step the door rolled up level and straight, skip this step.

- A. Check that guides are plum, square, level, and are properly mounted onto floor and wall.
- B. Check that the pipe is level.
- C. Check that the attachment of the curtain is straight on the pipe.

If all of the above is correct and the door still rolls up out of level, a shim may need to be added, as shown in **FIG 4S**.

Shim materials:

- A piece of rubber is the desired material for a shim.
- A piece of cardboard could be used but may deteriorate over time.
- Use a 1/8" x 6" x 6" thick piece of material and increase thickness or pieces depending on the result acquired, as shown in **FIG 4U**.

Application of shim:

- To determine the side in which the shim will be applied, the door will need to be in the open position.
- When facing the door, the bottom bar will be unlevel. The lower side of the bottom bar will be the side in which the shim needs to be placed.
- The hood may need to be loosened or removed for the application of the shim.

To apply the shim, two laborers might be required.

Installing the shim:

- D. Close the door fully.
- E. When door is at bottom make sure door is in hand chain mode.
- F. Turn off the power to the motor (if applicable) to ensure safe application of the shim.
- G. Backwind the door using the chain. Lock chain in place using chain keeper.

⚠ WARNING

When the door is wound backwards there is a force in which the door will want to wind forward. Secure the door in this position by locking hand chain onto chain keeper to prevent injury.

- H. As the curtain is wound backwards apply the shim to the lower side between the pipe and slats or on the ring of the low side.
- I. Restore power to the motor (if applicable).
- J. Check the level of the bottom bar while door is in the open position. If it is not level, add a second shim and check again.

NOTE: If the door has wind locks there may be some stacking interference in the wind locks as the door is wrapping during operation. This is a normal characteristic. For wind lock applications the doors bottom bar should be level at the open position.

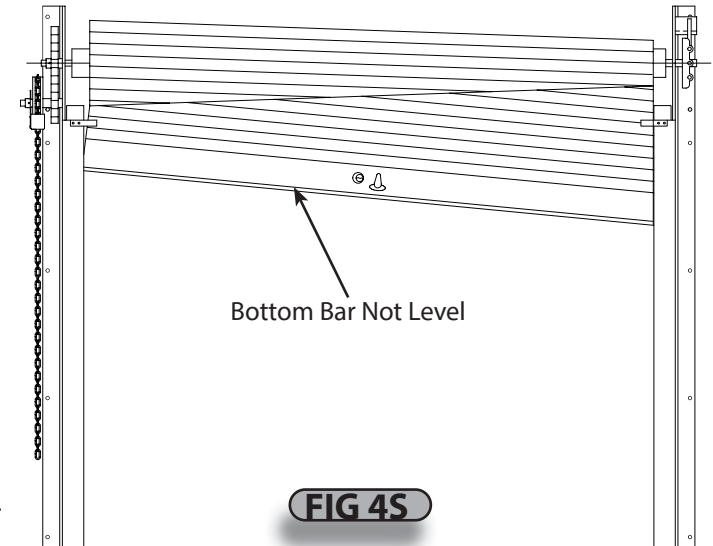

FIG 4S

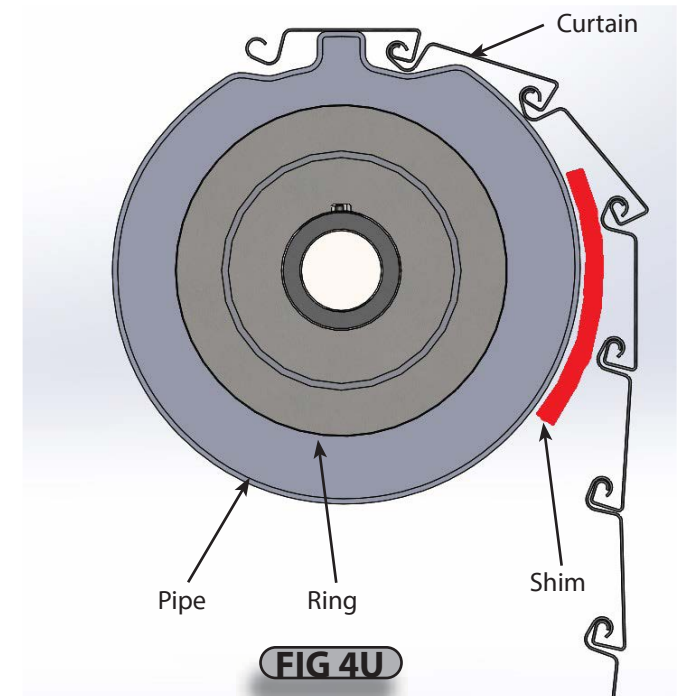

FIG 4U

Section 4 - Installation

STEP 18 INSTALL HOOD (exterior sloped hood is installed in a similar fashion)

- A. Pre-drill the hood flange at 18" spacing for wall mounting screws. Hole diameter is dependant on the size of the wall fasteners (not provided) used to attach hood to wall.
- B. Place the hood over the hood bands or straps on the headplates (and, if provided, hood supports) and **against** the wall, **FIG 4V**.
- C. Fasten the hood to the hood bands or straps.
 - At top, bottom and middle of the bands, drill 3/16" diameter holes through the hood and hood bands or straps on the headplates. Fasten the hood to the hood bands with self-tapping screws (provided).
- D. Fasten the hood to the wall.
 - Place fasteners using the pre-drilled holes (wall fasteners not included).

NOTE: Hood and Brush Seal installation can be delayed until the last step to allow easy access to curtain during wiring set-up and final adjustments.

HOOD SUPPORTS NOT SHOWN

NOTE: Install hood supports (if provided) at even intervals across header. Number and placement of hood supports will vary with hood type and width.



FIG 4V

Section 4 - Installation

STEP 19 FINAL INSTALLATION CHECK

CAUTION

Making the checks outlined below will help to ensure that the high cycle Springless Grille Door and operator are installed properly.

CHECK LIST

- Is the door level, square and plumb?
- Are all the bolts tightened?
- ARE ALL BEARING AND SET COLLARS POSITIONED, ARE SET COLLARS AND BEARING SET SCREWS TIGHTENED?
- Has all the rigging equipment, ropes, straps, etc. been removed?
- Are all safety labels and tags in place?
- Are all cable connections in the proper locations?

Section 5 - High Voltage Wiring

High Voltage Wiring

All High Cycle Springless Grille Door models are available in single phase 220VAC or 3-phase 230VAC. 460VAC and 575 VAC input power is available with the use of a step-down transformer. **YOUR LOCAL CODES MAY REQUIRE THAT THE INCOMING POWER TO YOUR High Cycle SPRINGLESS GRILLE DOOR HAVE A LOCK-OUT / TAG-OUT EQUIPPED FUSED DISCONNECT SWITCH (TO BE FURNISHED BY OTHERS) WITHIN EYESIGHT OF THE DOOR'S CONTROL PANEL.** Incoming power wiring must meet all NEC and local building codes, plus be properly sized for the control panel's amperage rating on the nameplate. To reduce the risk of electric shock, the chassis of the control panel must be properly grounded. Voltage at the door controller disconnect switch: 207-245v 3phase, 50/60HZ (230v systems) or 456-495v 3phase 50/60hz (460v systems). For 575v 3phase 50/60hz supply line, a step-down transformer must be installed to obtain 460v.

⚠ CAUTION

High Cycle Springless Grille Doors must be supplied by a properly grounded voltage supply, e.g. 220/240 VAC 1-phase or 208/230/460/575 VAC 3-phase. Floating (Open Delta) ungrounded voltage supply sources should not be used. For 480 VAC, 240 VAC or 120 VAC unbalanced Delta systems should **NOT** be used. Voltage unbalance is a common occurrence on delta supply systems, which power both single and 3-phase load. This can lead to unequal voltages on each phase leg. Voltage unbalance can cause deterioration of motor performance such as loss of torque, overheating, decreases in the winding insulation life, and can cause motor starter contacts on the control panel to permanently "weld" closed. Voltage unbalance can be caused by inadequate conductor sizing, delta transformer sizing, excessive single phase loads, poor grounding or intermittent high resistance faults which may cause destructive over-voltages to occur. If a 240 VAC 3-phase delta system must be used, it is strongly recommended that this voltage be transformed to a 220/240 VAC 1-phase grounded wye system. Any single phase loads should be evenly distributed as much as possible between the 3 phases. Consult a licensed electrician if you have any questions.

Wayne Dalton's warranty will not cover damage caused by failure of the motor, control panel or other electrical components due to the use of an inadequately grounded system.

STEP 1 VERIFY POWER SUPPLY JUMPER SETTING

- Locate the mains supply jumper on the control panel as shown in FIG 5A.
- Verify the jumper is set at 1.7 to 1.6 for 230V. If it is not, correct the setting.

STEP 2 WIRE STEP DOWN TRANSFORMER (IF APPLICABLE)

⚠ DANGER

LINE POWER will now be installed. Ensure that all incoming power supplies have been de-energized prior to beginning the following procedure. Use proper Lock Out/Tag Out procedures. Failure to de-energize the incoming power supply could result in severe injury or death. **A licensed electrician must perform the following step.**

- The controller will only accept 207-245VAC. If your building mains supply is 460VAC or 575VAC you will need to use a step down transformer. (Installed in STEP 12 on page 16).
- After insuring your supply voltage is not energized, connect it to the step down transformer.
- Wire the step down transformers output and direct it toward the controller.

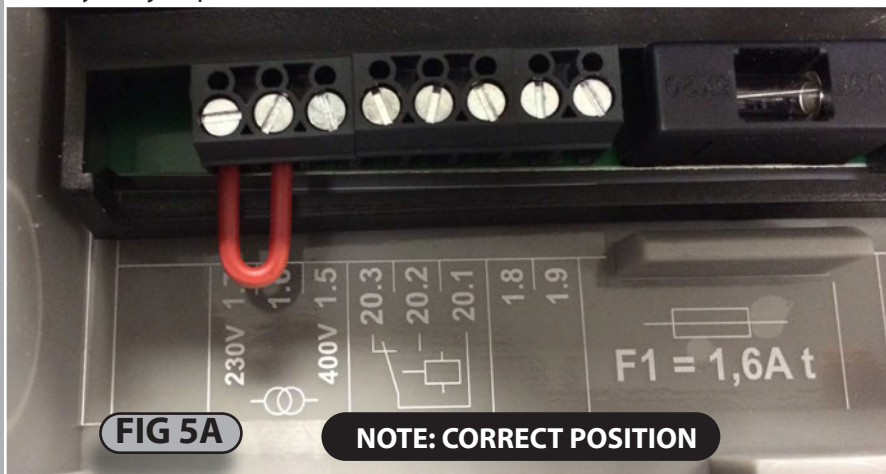

Section 5 - High Voltage Wiring - 3 Phase

STEP 3 CONNECT MAINS POWER - 3 PHASE

⚠ DANGER

LINE POWER will now be installed. Ensure that all incoming power supplies have been de-energized prior to beginning the following procedure. Use proper Lock Out/Tag Out procedures. Failure to de-energize the incoming power supply could result in severe injury or death. **A licensed electrician must perform the following step.**

-Connect mains power through the large knockout hole in the bottom of the control panel using a cable gland as shown in FIG 5B.

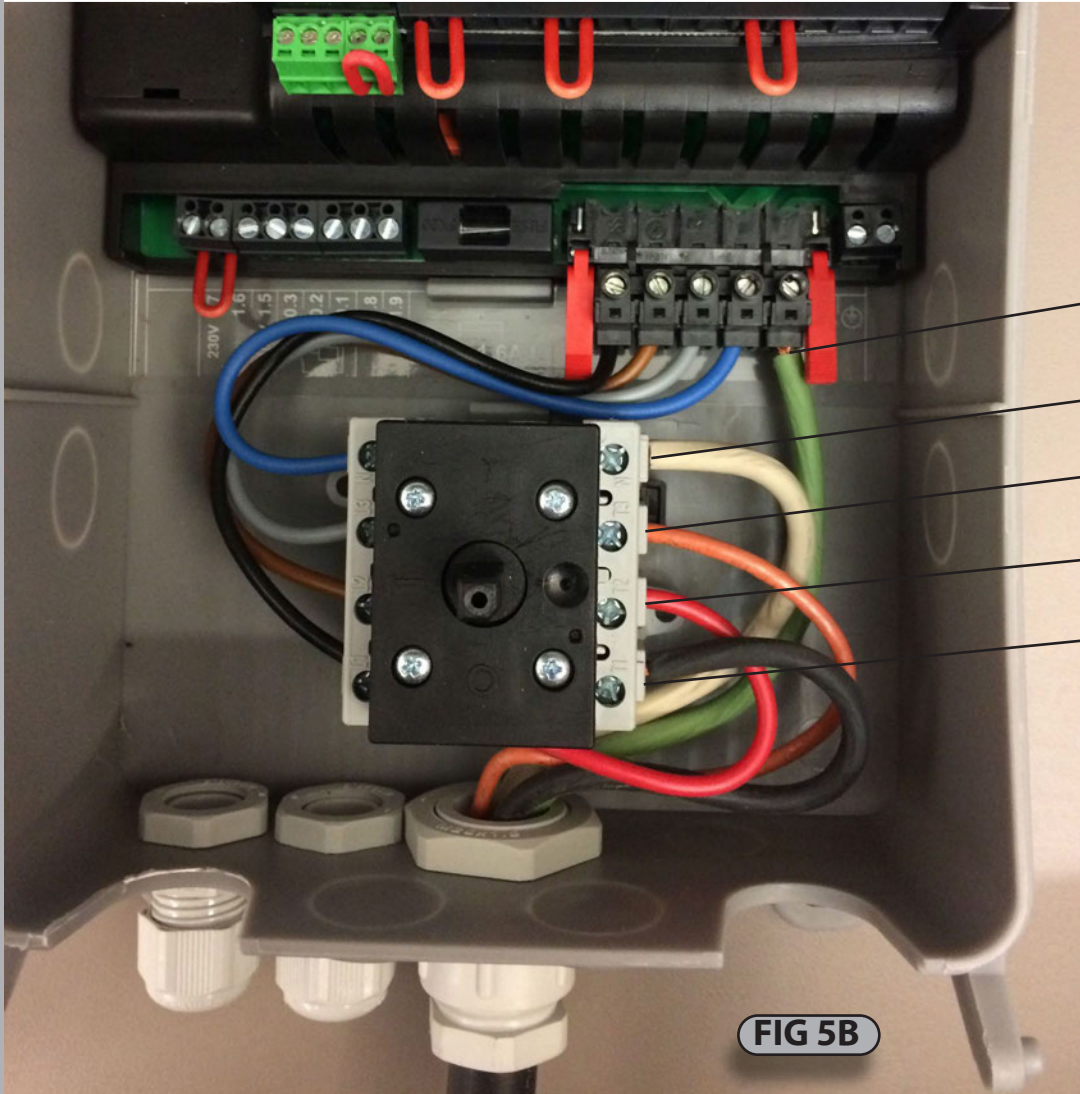

FIG 5B

NOTE: This page illustrates the connection of three phase power. If you have single phase skip to STEP 3 on page 26.

NOTE: Ground is not connected to the disconnect switch block. It is attached to the connector on the circuit board as shown.

- SAFETY
- GROUND
- GREEN
- NEUTRAL (OPTIONAL)
- PHASE 3
- PHASE 2
- PHASE 1

⚠ WARNING

Be sure to replace the red safety cover (shown in FIG 5C) after making the proper connections. If the unit is powered on without this safety cover in place it could expose the installers to dangerous voltage resulting in severe injury or death.

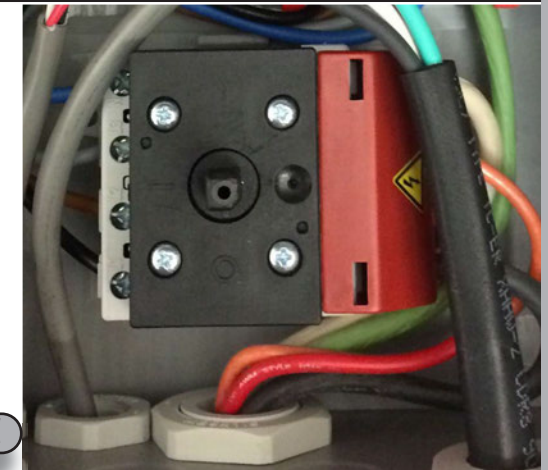

FIG 5C

STEP 4 POWER UP THE UNIT

Set the breaker switch, additional disconnects, and the disconnect on the unit to the ON position.

Section 5 - High Voltage Wiring - Single Phase

STEP 3 CONNECT MAINS POWER - SINGLE PHASE

⚠ DANGER

LINE POWER will now be installed. Ensure that all incoming power supplies have been de-energized prior to beginning the following procedure. Use proper Lock Out/Tag Out procedures. Failure to de-energize the incoming power supply could result in severe injury or death. **A licensed electrician must perform the following step.**

-Connect mains power through the large knockout hole in the bottom of the control panel using a cable gland as shown in FIG 5D.

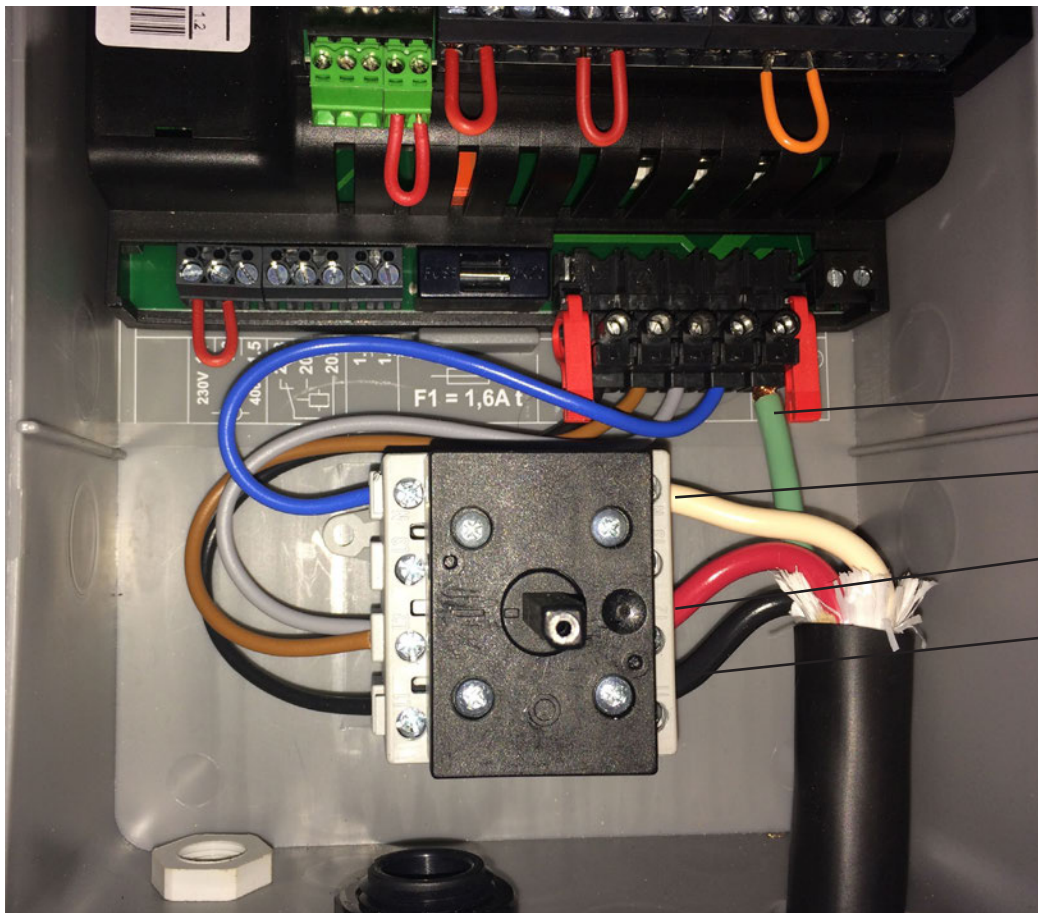

FIG 5D

NOTE: This page illustrates the connection of single phase power. If you have three phase follow STEPS 3 and 4 on page 25.

NOTE: Ground is not connected to the disconnect switch block. It is attached to the connector on the circuit board as shown.

⚠ WARNING

Be sure to replace the red safety cover (shown in FIG 5C) after making the proper connections. If the unit is powered on without this safety cover in place it could expose the installers to dangerous voltage resulting in severe injury or death.

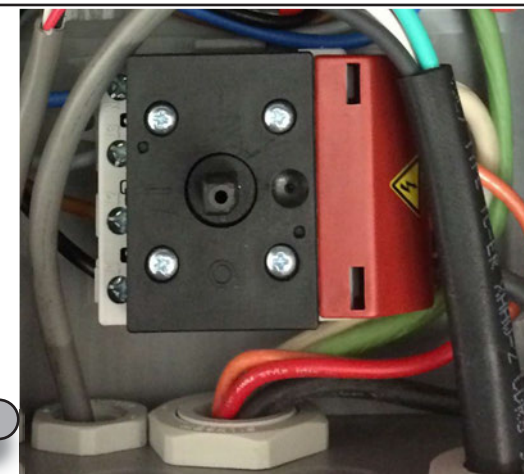

FIG 5C

STEP 4 POWER UP THE UNIT

Set the breaker switch, additional disconnects, and the disconnect on the unit to the ON position.

Section 6 - CONTROLLER PROGRAMMING

CONTROL OVERVIEW

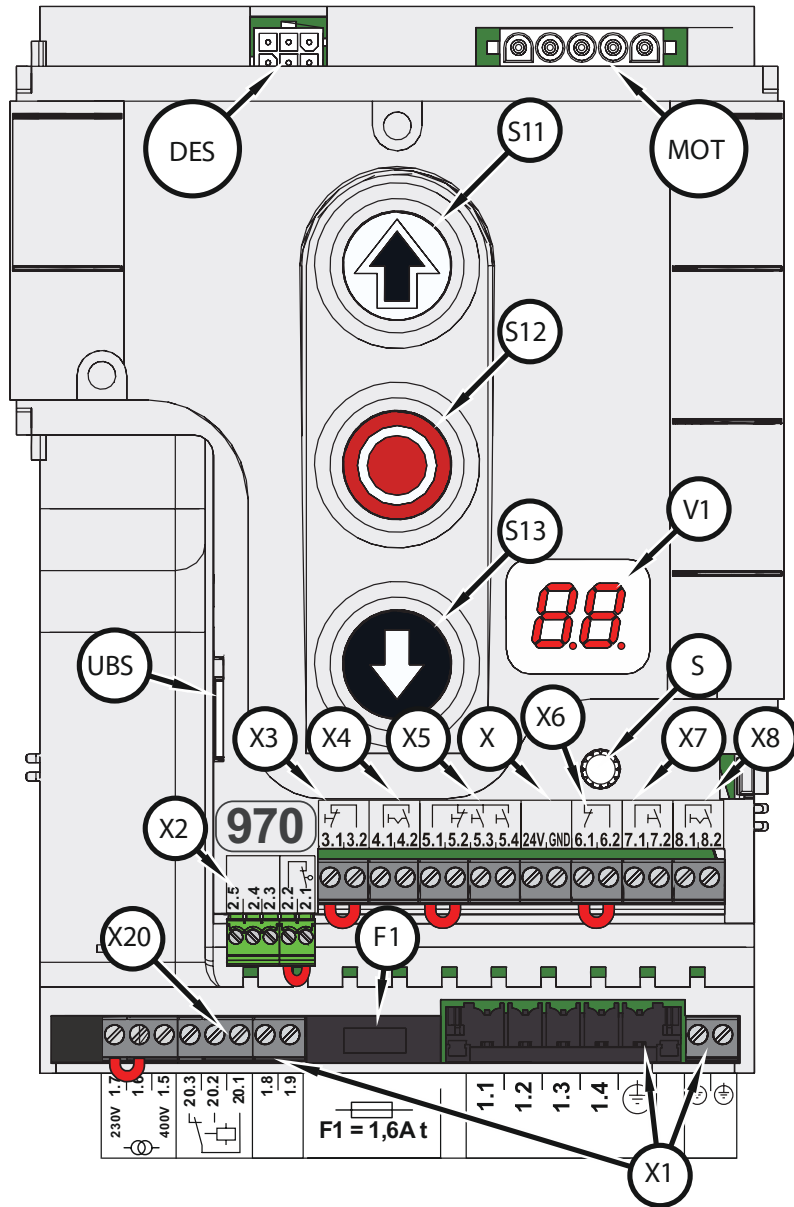

DES	DES socket
F1	Micro-fuse 1.6A time lag
MOT	Motor Socket
S	Selector Switch
S11	Open Push Button
S12	Stop Push Button
S13	Close Push Button
UBS	Universal Command Sensor Socket
V1	Display
X	24V Mains Supply, External Devices
X1	Mains Supply
X2	Monitored Photoeye or Safety Edge and Interlock Switch
X3	Emergency Stop Control Device
X4	Automatic Closing On/Off
X5	Control Device External Three Button Station
X6	Photoeyes
X7	Pull Switch
X8	Intermediate Stop On/Off
X20	Potential-free Relay Contact

Section 6 - CONTROLLER PROGRAMMING

GENERAL CONTROLLER PROGRAMMING PROCEDURE

STEP 1 START PROGRAMMING MODE

Refer to the controller layout diagram on page 26. Locate the selector switch marked "S". This is the main control mechanism used in all programming.

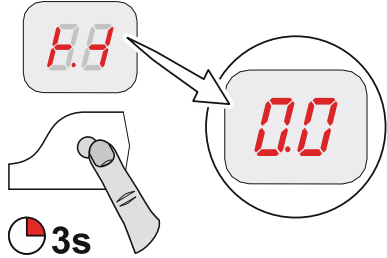

NOTE: Only possible after rapid adjustment of final limit positions.

STEP 4 EXIT PROGRAMMING MODE

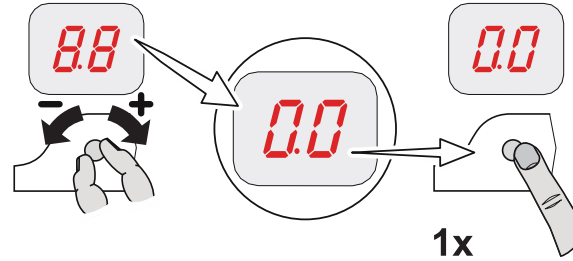

STEP 2 SELECT MENU ITEM AND CONFIRM

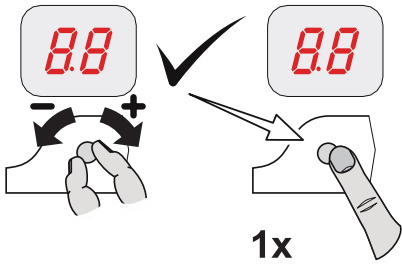

STEP 3a SET AND SAVE FUNCTIONS

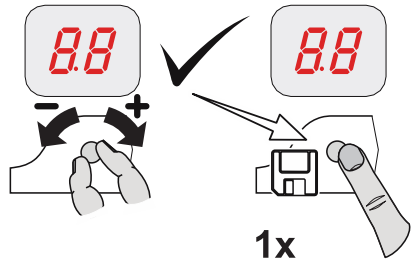

STEP 3b SET AND SAVE FUNCTIONS

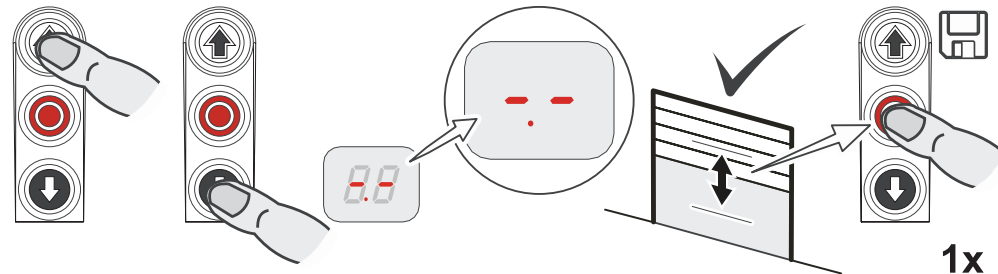

Section 6 - CONTROLLER PROGRAMMING

DES: RAPID ADJUSTMENT OF FINAL LIMIT POSITIONS

STEP 1 CHECK OUTPUT ROTATING DIRECTION

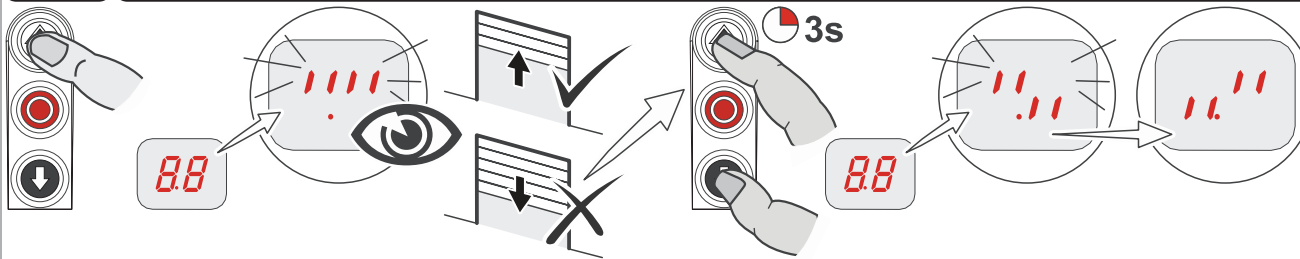

STEP 2 MOVE TO OPEN FINAL LIMIT POSITION

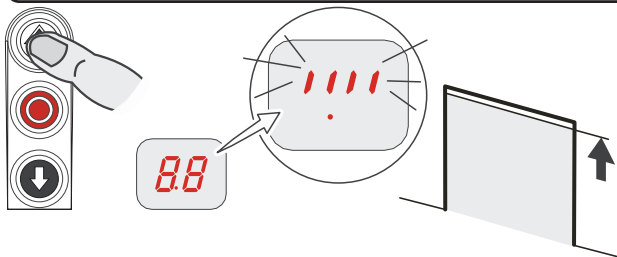

STEP 3 SAVE OPEN FINAL LIMIT POSITION

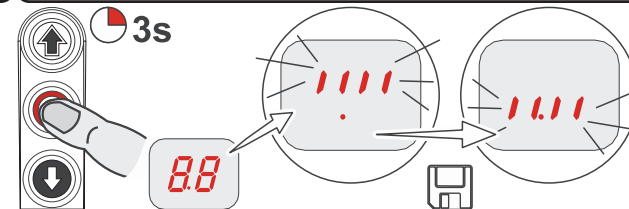

STEP 4 MOVE TO CLOSE FINAL LIMIT POSITION

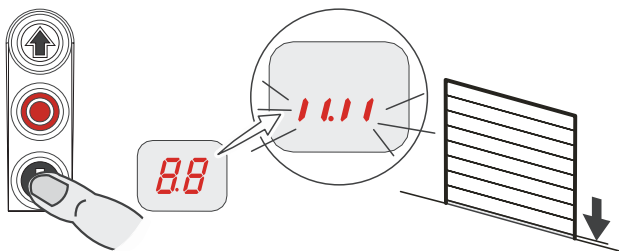

STEP 5 SAVE CLOSE FINAL LIMIT POSITION

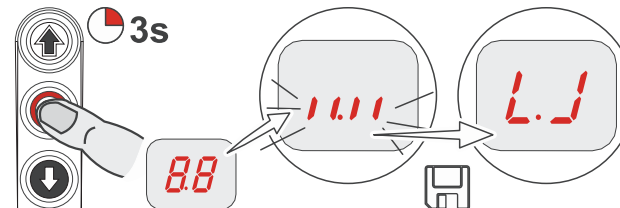

NOTE:

- The rapid adjustment is complete, constant pressure door operating mode is active.
- Pre-limit switch safety edge is set automatically.
- Changing the pre-limit position is possible via menu item 1.5.
- Refer to page 32 for setting up one touch operating mode.

⚠ WARNING

All Entrapment Protection Devices are **OFF** in constant pressure operating mode. **USE CAUTION! WHILE OPERATING THE DOOR IN THIS MODE. Do NOT use this mode for general door operation. Serious injury or death could result from someone standing in the doorway while the door is lowered in this mode.**

Section 6 - CONTROLLER PROGRAMMING

STEP 1 ALIGN PHOTOEYES

(Retroreflective) Photoeye wiring connections were completed in a previous step (Mounting Electrical components on page 17).

- Final adjustment of the Photoeyes will be made **after power is supplied to the door system.**
 - Verify the Photoeye green power LED is on, indicates power is on.
 - Loosen the mounting screws on Photoeye receiver and adjust position until the yellow LED on is steadily on. (LED will flash when receiving a weak signal)
 - Lock the mounting screws down, being sure not to move the Photoeyes out of alignment.

(Optional Thrubeam) Photoeye wiring connections were completed in a previous step (Mounting Electrical components on page 17).

- Final adjustment of the Photoeyes will be made **after power is supplied to the door system.**
 - Verify the Photoeye transmitter LED is on, indicates power is on.
 - Loosen the mounting screws on both Photoeyes and adjust position until the LED on the receiver is steadily on.
 - Lock the mounting screws down, being sure not to move the Photoeyes out of alignment.

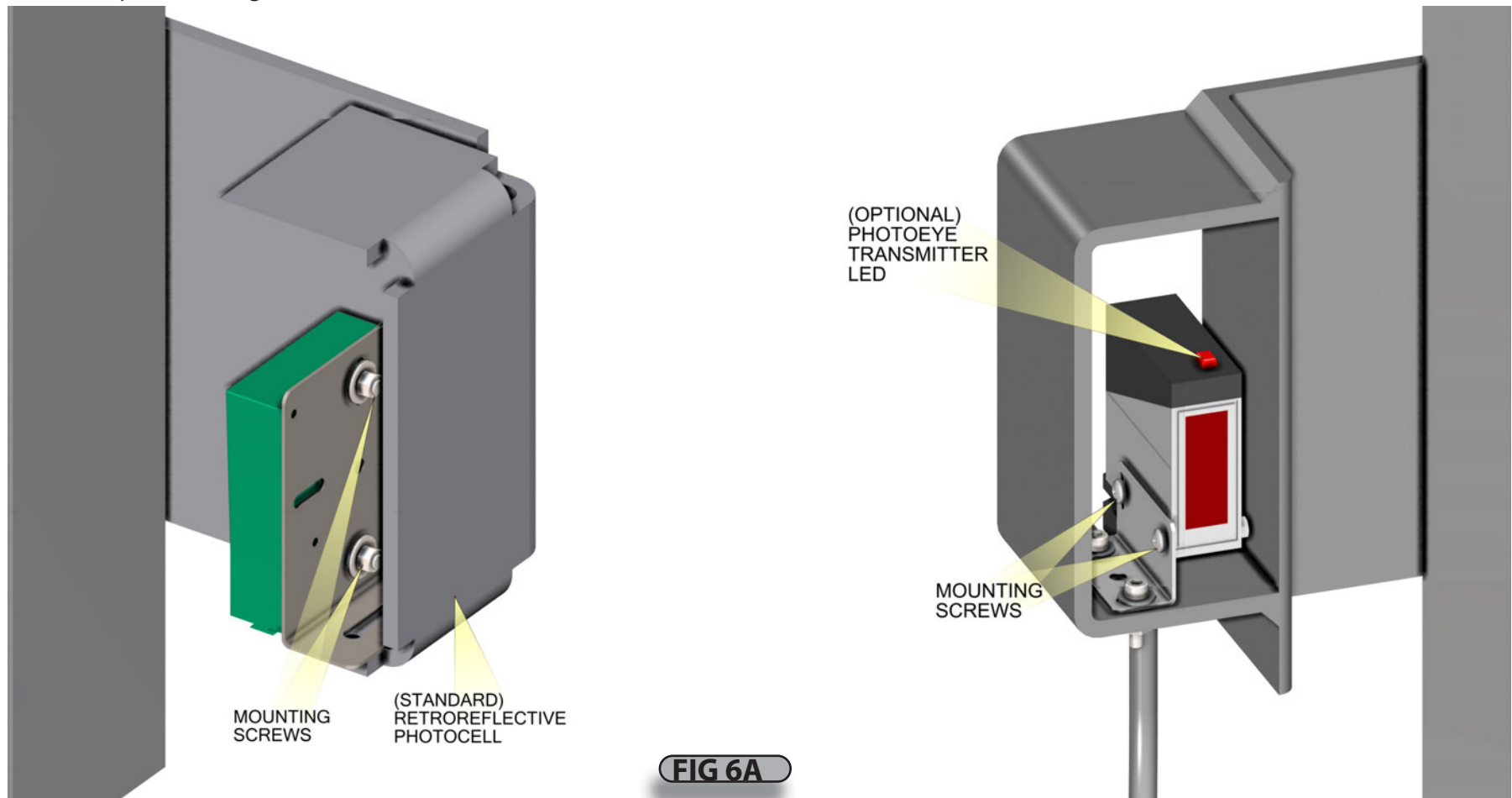

FIG 6A

Section 7 - Service and Maintenance

INSTALLATION DATE:			
	EVERY DAY	EVERY 6 MOS. OR 50,000 CYCLES	EVERY 12 MOS. OR 100,000 CYCLES
GENERAL INSPECTION		●	
MANUAL OPERATION OF DOOR		●	
PHOTOEYES AND OTHER SAFETY DEVICES	●		
MOUNTING BOLT TIGHTNESS			●
CHECK LIMIT POSITION		●	

Table 7-A

Service Interval Message

- When cycles indicate service is required, the panel will display "CS".
- Once service is completed, clear the service message by resetting the maintenance cycle counter according to the instructions on page 36.

General Inspection

- Visually inspect wiring conduit and cables.
- Inspect fixtures such as: bearings, conduit boxes, control panel, hood, gearbox (for oil leakage), motor.
- All bearings provided with grease fittings should be lubricated. If so equipped, find bearings located in the drive bracket and tension end of the counterbalance.
- Inspect safety labels, placement and condition.

Manual Operation of Door

- Inspect door alignment and level.
- Inspect slats and endlocks for damage.
- Inspect guides and UHMW wear strip, bottom bar and hood for damage.
- Inspect all weather-stripping for wear or damage.
- Inspect and tighten shaft collars.

Mounting Bolt Tightness

- Check fasteners anchoring headplates and door guides to wall.
- Inspect operator mounting.

CAUTION

Failure to perform specified service and maintenance may result in an unsafe condition, will void limited warranty, and may result in premature failure of the unit. Service and Maintenance are necessary to ensure safe operation of the EverServe door.

NOTE: Table 9-A provides a schedule of Service and Maintenance items.

NOTE: Keep records of all service and maintenance.

NOTE: Advanced technical support is available at 1-800-764-1457 option 4.

Electric Operator

- Inspect operator mounting.
- Inspect and test disconnect.
- Inspect safety labels, placement and condition.

Photoeye & Sensing edge systems

- Test Photoeye activation daily.
 - Obstruct the Photoeye beam with a solid object. Photoeye should reverse door direction.
- Test Sensing edge (if equipped) activation daily
 - Place a solid object, higher than 12", on floor and close door. Sensing edge should reverse door direction on contact with object.

Check Limit Position

- Verify the door stops at correct open position.
- Verify that door closes fully without excessive "stacking" of curtain in guides.
- Verify approach speeds provide for smooth starts and stops.



Rolling Steel Models 600 HC Springless High Cycle Grille System Limited Warranty

Wayne Dalton, a division of Overhead Door Corporation ("Seller") warrants to the original purchaser of the Model 600 Rolling Grille with High Cycle System Option ("Product"), subject to all of the terms and conditions hereof, that the Product and all components thereof will be free from defects in materials and workmanship for the following period(s) of time, measured from the date of installation:

- **Seller warrants all mechanical door system components and the control panel hardware for a period of 24 MONTHS or 300,000 cycles*, whichever occurs first.**

Seller's obligation under this warranty is specifically limited to repairing or replacing, at its option, any part which is determined by Seller to be defective during the applicable warranty period. Any labor charges are excluded and will be the responsibility of the purchaser.

This warranty is made to the original purchaser of the Product only, and is not transferable or assignable. This warranty does not apply to any unauthorized alteration or repair of the Product, or to any Product or component which has been damaged or deteriorated due to misuse, neglect, accident, failure to provide necessary maintenance, normal wear and tear, or acts of God or any other cause beyond the reasonable control of Seller. This warranty does not apply to any damage or deterioration caused by door curtain rubbing together as the door rolls up upon itself or caused by exposure to salt water, chemical fumes or other corrosive or aggressive environments, whether naturally occurring or man-made, including, but not limited to, environments with a high degree of humidity, sand, dirt or grease. Wearing away of the painted surfaces of the Product is a common occurrence resulting from the curtain repeatedly coiling upon itself and uncoiling during normal usage (See DASMA #274), and is specifically excluded from this warranty. Seller does not warrant that the Product software will provide error-free operation or be free from defects.

THIS WARRANTY IS EXCLUSIVE AND IN LIEU OF ANY OTHER WARRANTIES, EITHER EXPRESS OR IMPLIED, INCLUDING BUT NOT LIMITED TO ANY IMPLIED WARRANTY OF MERCHANTABILITY OR FITNESS FOR A PARTICULAR PURPOSE.

IN NO EVENT SHALL SELLER BE RESPONSIBLE FOR, OR LIABLE TO ANYONE FOR, SPECIAL, INDIRECT, COLLATERAL, PUNITIVE, INCIDENTAL OR CONSEQUENTIAL DAMAGES, even if Seller has been advised of the possibility of such damages. Such excluded damages include, but are not limited to, loss of use, cost of any substitute product, or other similar indirect financial loss.

Claims under this warranty must be made promptly after discovery, within the applicable warranty period, and in writing to the authorized dealer or installer whose name and address appear below. The purchaser must allow Seller a reasonable opportunity to inspect any Product claimed to be defective prior to removal or any alteration of its condition. Proof of the purchase and/or installation date, and identification as the original purchaser, may be required.

*The number of cycles referred to herein shall be measured by an integrated cycle counter contained in or attached to the Product. If the cycle counter is rendered inoperable, Seller shall use other reasonable means to determine the cycle count.

Door Type: _____

Customer Name (Original Purchaser): _____

Customer Installation Location: _____

Order # _____ Date of Installation: _____

Name of Dealer/Installer: _____

Signature of Dealer/Installer: _____

Rev. 05.2019

APPENDIX A - CONTROLLER MANUAL

CONTROLLER MANUAL

The following section is a portion of the controller manual. It contains information for wiring and setting up optional switches and safety devices, as well as a troubleshooting section.

APPENDIX: TABLE OF CONTENTS

SECTION	CONTENTS	PAGE	SECTION	CONTENTS	PAGE
8	TABLE MENU ITEMS	35-43		X5: Input control device	51
	Door operating modes	35		X6: Input, Photocell and light curtain non-monitored	52-54
	Door positions	36		X7: Input, pull switch, radio receiver	54
	Door functions	37-40		X8: Input, intermediate stop on/off	55
	Safety functions	40		Potential-free X20 relay contact	56
	DI/FI Settings	41		Force monitoring	56-57
	Maintenance cycle counter	42		Maintenance cycle counter	58
	Readout of data memory	43		Short-circuit/overload display	58
	Deleting of all settings	43		Standby function	58
9	SAFETY DEVICES	44-49	11	STATUS DISPLAY	59-65
	X2: Input, door safety switch function	44	12	EXPLANATION OF SYMBOLS	66-67
	X2: Input safety edge system	45			
	Installation of spiral cable	46-48			
	Emergency operation	49			
	X3: Input, emergency stop	49			
10	FUNCTION DESCRIPTION	50-58			
	X: 24 VDC voltage supply	50			
	X1: Mains supply for external devices	50			
	X4: Input, Automatic closing Off/On	51			

APPENDIX A - CONTROLLER MANUAL

SAFETY SYMBOLS

In the appendix the warnings will use the following symbols.

Symbols



Warning - Risk of injury or danger to life!



Warning - Danger to life from electrical current!













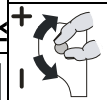
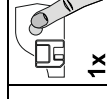

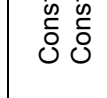
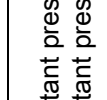
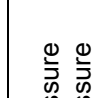

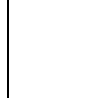



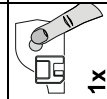

















Note - Important information!



Prompt - Required action!

8 Table menu items

Door operating modes	
Door operating mode	Door operating mode
	
	
	Constant pressure Constant pressure
	One touch automatic operation Constant pressure
	One touch automatic operation One touch automatic operation
	One touch automatic operation One touch automatic operation , CLOSE Constant pressure release via external X5 control device
	Constant pressure Constant pressure with active safety edge
	
	
	
	
	
	
Output rotating direction	Output rotating direction
	
	
	
	
	
	
	
	
	
	
	
	
	

Door positions						
			OPEN final limit position, coarse correction (DES)			
			CLOSE final limit position, coarse correction (DES)			
			OPEN final limit position, fine correction (DES)			
			CLOSE final limit position, fine correction (DES)			
			Fine-correction pre-limit switch for safety edge (DES)			
			Adjust intermediate open X8 (DES)*			
			Setting for position of relay switching point (DES)*			

Approach and store desired door position

Approach and store desired door position

Approach and store desired door position

Approach and store desired door position

Approach and store desired door position

Approach and store desired door position

Without door movement,
[+] OPEN correction
[-] CLOSE correction

Without door movement,
[+] OPEN correction
[-] CLOSE correction

Without door movement,
[+] OPEN correction
[-] CLOSE correction











Without door movement,
[+] OPEN correction
[-] CLOSE correction

Approach and store desired door position

Approach and store desired door position

*) Menu items 1.6 to 1.7 disappear at NES. The switching point must be adjusted via the S6 auxiliary limit switch at the drive unit.

Door functions, part 1

Safety edge function in the pre-limit area		 1x	 1x
 2.1	 1	Safety edge active	 1x
	2	Safety edge inactive	
	3	Ground adjustment (DES) (Activation of safety edge at ground contact)	
	4	Reversing in upwards direction in overrun area (DES)	
Overrun correction (DES)		 1x	 1x
 2.2	 0	Off	 1x
	1	On (Do not use with ground adjustment)	

Door functions, part 2



Automatic closing								
2.3				0.0	1x	2.-	4.0	0 to 240 seconds
Extended photo cell function								
2.4				.0	1x	Off		
				.1	Cancel automatic closing and CLOSE command			
				.2	Vessel recognition Cancellation of automatic closing and CLOSE-command if photo cell activation duration > 1.5 seconds			
Reversing								
2.5				0.0	1x	1.0	0 = Off 1 to 10 safety-device activations	0.2
Pull switch or radio receiver function X7								
				.1	Type of impulses 1 Door is in OPEN final limit position CLOSE command Door is not at OPEN final limit position OPEN command			
				.2	Type of impulses 2 Command order OPEN – STOP – CLOSE – STOP – OPEN			
				.3	Type of impulses 3 OPEN command only			

Door functions, part 3





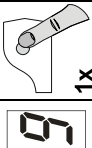

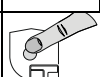
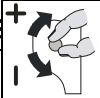
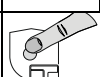
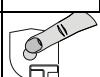



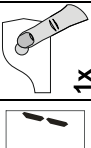





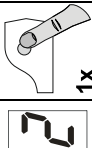

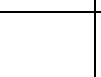
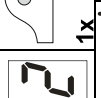
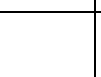
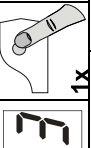





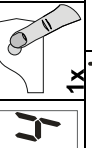

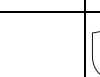
Relay function on X20		1x	1x
2.7	0	Off	1x
.	1	Impulscontact* for 1 second	
.	2	Permanent contact*	
.	3	Red lamp, permanently lit during door movement OPEN final limit position Flashing for 3 seconds CLOSE final limit position Flashing for 3 seconds	
.	4	Red lamp, permanently lit during door movement OPEN final limit position Flashing for 3 seconds CLOSE final limit position Off	
.	5	Red lamp, permanently lit during door movement OPEN final limit position Permanently lit for 3 seconds CLOSE final limit position Permanently lit for 3 seconds	
.	6	Red lamp, permanently lit during door movement OPEN final limit position Permanently lit for 3 seconds CLOSE final limit position Off	
.	7	Dock leveller release or permanent green light Active only in OPEN final limit position	
.	8	Permanent contact in CLOSE final limit position	
.0	10	Light sensing device 1-second pulse at each OPEN command	
.1	11	Permanent contact at door position*	
.2	12	Brake control Active during operation Inactive at stop	
.4	14	Light curtain test, etc. Test prior to each closing operation	

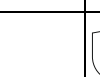
*) Previous teach-in of door positions via menu item 1.7 Relais X20 (only DES) or respectively via the S6 auxiliary limit switch of the drive unit (NES).

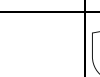
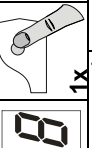
Door functions, part 4

Intermediate open function					
2.9		1	All command inputs		
		1x			
2	.	2	Input X7.2		
3	.	3	Input X5.3 and OPEN push-button of control		

Safety functions

Force monitoring (DES)					
3.1		0	0 = Off		
		1	Adjustable for 2 % to 10 % overload		
3.2	.	2	10		
Interruption of the photo cell function (DES)					
3.2		0	Off		
		1	On (single reference position taught-in twice)		
3.3		00	0 = Off		
		1	0 to 90 seconds		
3.4	.	2	90		
Door safety switch function (Input X2.2)					
3.4		1	Slack-rope / Pass-door switch		
		2	Crash switch as NC contact After activation changeover to "Hold-to-run" door operating mode		
		3	Crash switch as NO contact After activation changeover to "Hold-to-run" door operating mode		
3.8		-0	Reversing duration adjustment		
		1	[+] slower		
		2	[-] faster		

DI/FI settings

41		OPEN output speed				Output speed in rpm		1x	
42		CLOSE output speed				Output speed in rpm		1x	
43		Increased CLOSE output speed Up to an opening height of 2.5 m				Output speed in rpm 0 = Off		1x	
44		Changeover position to CLOSE output speed (with adherence to minimum opening height requirement of 2.5 m!)				Approach and store desired door position		1x	
45		OPEN acceleration				DI FI		1x	
46		CLOSE acceleration				DI FI		1x	
47		OPEN deceleration				DI FI		1x	
48		CLOSE deceleration				DI FI		1x	
49		OPEN/CLOSE crawling speed				Output speed in rpm		1x	

Maintenance cycle counter

Maintenance cycle preselection		Maintenance cycle counter		Maintenance cycle counter		Maintenance cycle counter	
8.5	1x	Maintenance cycle preselection					
-		0.0	0.1	9.9		0.0	
+		0.0		01-99 corresponds to 1000-99000 cycles are counted down		1x	
-		0.0		Reaction upon reaching zero			
+		0.0		Status indication "CS" appears in turns with value set by menu item 8.5.		1x	
-		0.1		Changeover to "hold-to-run" door operating mode. Status indication "CS" appears in turns with value set by menu item 8.5.			
+		0.2		Changeover to "hold-to-run" door operating mode. Status indication "CS" appears in turns with value set by menu item 8.5.			
-		0.3		Option: Press STOP-button for 3 seconds to deactivate changeover and status indications for 500 cycles.			
+		0.4		Status indication "CS" appears in turns with value set by menu item 8.5 and relay contact X20 switches.			

Readout of Data memory

		Cycle counter 7-digit number									
		M	HT	ZT	T	H	Z	E			
		Displayed in division of ten consecutively M = 1,000,000 ZT = 10,000 H = 100 E = 1 HT = 100,000 T = 1,000 Z = 10									
		Last faults									
		Display change of the last 6 faults									
		Data counter 7-digit number									
		M	HT	ZT	T	H	Z	E			
		Displayed in division of ten consecutively M = 1,000,000 ZT = 10,000 H = 100 E = 1 HT = 100,000 T = 1,000 Z = 10									
		Cycle counter of the last change in programming									
		Number of activations of slack-rope, pass-door and crash switch									
		Software version									
		The firmware version of the control is displayed. Additionally the software version of the motor is displayed for DI-drives and FI-drives.									

Deleting / Readout

		Deleting of all settings									
		Activating GfA stick									
		All settings are set to factory setting! Except for cycle counter									
			1x								

9 Safety devices

X2: Input, door safety switch function

The door safety switch is installed on the door and connected to the door control via the spiral cable.

Menu item "3.4":

Function	Reaction upon activation
„1“ Slack-rope/Pass-door	<ul style="list-style-type: none">• Switching contact is interrupted: Door stop• Switching contact is closed: Door is ready for operation
„2“ Crash switch as NC contact	<ul style="list-style-type: none">• Door stops• Changeover to "Hold-to-run" door operating mode• Frequency inverter: "Hold-to-run" door operating mode at crawling speed only• Fault reset only possible in OPEN final limit position: Press the STOP-button of the door control for 3 seconds
„3“ Crash switch as NO contact	Like function „2“

Slack-rope/pass-door

If the pass-door switch is open circuit when an open or close command is given, fault "F1.2" is displayed. If activated during the door movement, the door is immediately stopped and fault "F1.2" is displayed.

Entrysense (electronic pass-door switch)

The pass-door switch, which has been tested to performance level c (plc) in accordance with EN 13849-1, is monitored by the door control. If the pass-door switch is open circuit when an open or close command is given, fault "F1.2" is displayed. If activated during the door movement, the door is immediately stopped and fault "F1.2" is displayed.

The magnetic contacts in the pass-door switch are switched by a permanent magnet. The door control assesses the switching status of the contacts independently of each other. The "F1.7" fault indication appears if there is a fault.

Crash switch as NC or NO contact

The crash switch is activated if the door is pushed out of the guides.

If the switching contact is activated, the door is stopped, fault indication "F4.5" is displayed, and a changeover to "Hold-to-run" door operating mode is carried out. The door can be moved only via the built in push button of the door control. "Hold-to-run" door operating mode for frequency inverter only at crawling speed.

The fault indication "F4.5" can only be reset in OPEN final limit position by pressing the STOP-button of the door control for more than 3 seconds or by switching the mains voltage off and on. Fault "F4.5" will recur, if the switching contact continues to be activated.

X2: Input, safety edge system

The door control automatically detects three different safety edges to protect the closing movement of the gate wing.



Important!

- Connect safety edges in accordance with EN 12978
- "Hold-to-run" door operating mode can always be used should the safety edge be defective

Electrical safety edge

The input is meant for an electrical safety edge (NO) with a terminal resistance of K2 (+/-5% and 0,25W).

If there is a short circuit, fault indication "F2.4" is displayed.

If there is an open circuit, the "F2.5" fault indication appears.

Pneumatic safety edge

The input is meant for a pressure wave switch system (NC) with a terminal resistance of 1K2 (+/-5% and 0,25W).

Upon activation or permanent disconnection of the current circuit, the "F2.6" fault indication appears.

If there is a short circuit, fault indication "F2.7" is displayed.

The pressure wave switch system needs to be tested with CLOSE final limit position. The test phase is initiated by the pre-limit switch (automatically for DES). If no switching signal is generated on the pressure wave switch within 2 seconds, the test is negative and the fault indication „F2.8“ is displayed.

Optical safety edge system

The input is meant for an infrared safety beam sensor with transmitter and receiver in a rubber profile. By pressing the rubber profile, the light beam is interrupted.

The "F2.9" fault indication appears upon activation or a faulty safety edge system

Installation of the spiral cable

The spiral cable should enter the door control panel from the left- or right-hand side. The spiral cable should be fixed in place with a cable gland. The safety edge system is connected via the 3-pole plug, and the slack-rope or the pass door via the 2-pole plug.



Important!

- ▶ Check position of S5 pre-limit switch on the safety edge (only for NES)
- When the door is opened > 5cm, a reversing must be executed if the safety edge has been activated

Function: Safety edge function in the pre-limit area

Menu item "2.1":

Function	Reaction to activation of safety edge
"1" Active	<ul style="list-style-type: none">• Door stops
"2" Inactive	<ul style="list-style-type: none">• No reaction• Door moves to CLOSE final limit position
"3" Ground adjustment (DES)	<ul style="list-style-type: none">• Door stops; correction of the CLOSE final limit position at the next closing
"4" Reversing in overrun area (DES)	<ul style="list-style-type: none">• Reversing upwards from the overrun area upon activation of the safety edge system

! Note: Ground adjustment!

- Automatic compensation of rope elongations or changes in ground conditions of approx. 2-5 cm
- With DES limit switch only
- Do not use with overrun correction
- Do not use with pneumatic switch

! Note: Reversing upwards in the overrun area!

- To maintain the operating forces in the pre-limit area
- At high speeds
- With DES limit switch only
- Function for FI-drive units not necessary

Function: Overrun correction function (only DES)

Menu item "2.2":

Automatic limit switch correction to achieve a constant CLOSE position.

Function	Overrun correction
„0“	Off
„1“	On



Note: Overrun correction!

- With DES limit switch only
- Do not use with ground adjustment

Function: Reversing

Menu item "2.5":

Limiting of reversing following safety edge system activations via automatic closing.

If the set value is exceeded, automatic closing is deactivated and the "F2.2" fault indication is displayed.



Note!

- To reset fault "F2.2": Move to CLOSE final limit position

WARNING

All Entrapment Protection Devices are **OFF** in Emergency Operation mode. **USE CAUTION! WHILE OPERATING THE DOOR IN THIS MODE. Do NOT use Emergency Operation mode for general door operation. Serious injury or death could result from someone standing in the doorway while the door is lowered in this mode.**

EMERGENCY operation



Warning!

- ▶ For EMERGENCY operation, the door has to be checked (it has to be in a fault-free state)
- “Hold-to-run” door operating mode:
The door must be fully visible from the operating point

EMERGENCY operation allows for moving the door to a required position by bypassing faults with the signal transmission of the safety device. EMERGENCY operation is activated after pressing the STOP push-button and holding for 7 seconds, and is indicated by the flashing display.



Note!

- The door cannot be moved in case of “F1.3” and “F1.4” fault indications for reasons of operating safety.
- ▶ Activation of EMERGENCY operation: Use the built in push button of the control to press and hold the STOP-button while simultaneously pressing the OPEN or CLOSE push-button to move the door

X3: Input, emergency stop

Connection of an emergency stop control device as per EN 13850 or an evaluation unit for an anti-trap safety device. The “F1.4” fault indication appears upon activation.



Note!

- Frequency inverter drive unit: The emergency stop switches the supply off. The door control can only be operated again 30 seconds after unlocking the emergency stop. (Display rotates during this time)



10 Functional description

X: 24 VDC voltage supply

Connection of external devices such as photo cell, radio receiver, relay, etc. via the "24 V" and "GND" terminals.



Attention – Damage to components!

- Total current consumption of external devices: maximum 180 mA

See Appendix C for typical current consumption

X1: Mains supply of the control and supply of external devices

Mains supply of the control

Connection via the terminals X1/1.1 to X1/1.4 and PE.

Various mains connections: 3 N~, 3~, 1 N~ for symmetric and asymmetric motors.

Power supply 230 V = Wire link 1.6 – 1.7



Note!

- ▶ Pay attention to the "Mains supply connection" and "Mains supply connection to control" descriptions

Supply of external devices

Connection of external devices for 230 V, such as photo cell, radio receiver, relay, etc. via terminals X1/1.8 and X1/1.9.



Note!

- Mains supply: 3 N~400 V or 1 N~230 V, symmetric
Protection via F1, 1.6-A time-lag micro-fuse

X4: Input, automatic closing Off/On

Connection of a switch via the terminals X4/1 and X4/2 for switching the automatic closing off and on.

⚠ WARNING

All Entrapment Protection Devices are **OFF** in Hold-To-Run mode. **USE CAUTION! WHILE OPERATING THE DOOR IN THIS MODE. Serious injury or death may result from someone standing in the doorway while the door is lowered in this mode.**

X5: Input, control device



Warning!

- ▶ "Hold-to-run" door operating mode:

The door must be fully visible from the operating point

The door operating mode "3" allows a place of installation of the control device without sight of the door.



Note!

- ▶ Application without STOP push-button: Connect wire link X5.1 to wire link X5.2
 - If the safety edge or photo cell fails, the control device will not function

X6: Input „Through / reflective photo cell“ resp. light curtain

Photo cell

A photo cell is used for presence detection. It is only active in door operating modes ".3" and ".4", in the OPEN final limit position or during the CLOSE-operation. If the light beam is interrupted, fault indication "F2.1" appears.

Light curtain

The light curtain must be self-testing and correspond at least to safety category 2 or performance level c (plc). If the light curtain corresponds to these requirements, the door can close into self-hold without safety edge system.



Important!

- ▶ Operation without safety edge: Connect resistor 8K2 via the terminals X2/3 and X2/4
- ▶ Photo cells must not be used via the UBS system if a light curtain is used
- ▶ Do not use menu item "3.2" for the light curtain

- ▶ To test the light curtain, activate relay contact X20.

The relay functions are described under menu item "2.7" / "2.8".

If the light beam is interrupted, fault indication "F4.6" appears.

A testing is carried out with every CLOSE-command. Thereby the contact of the light curtain must switch off within 100 ms. If the test is positive, the contact must switch back on within 300 ms. If the test is negative, the fault indication "F4.7" is displayed.

- ▶ To reset fault indication "F4.7": Switch control off and on.



Note!

- ▶ Only use photo cells or light curtains with "Light switching" mode

Reaction to interrupting of light beam

Door position	Reaction to interrupting of light beam
CLOSE final limit position	<ul style="list-style-type: none"> No action
OPEN-operation	<ul style="list-style-type: none"> No action
OPEN final limit position Without automatic closing	<ul style="list-style-type: none"> No action
OPEN final limit position With automatic closing	<ul style="list-style-type: none"> Reset automatic closing
OPEN final limit position With automatic closing and interruption to timer	<ul style="list-style-type: none"> The door closes 3 seconds after the interruption period for the light beam has ended

Extended photo cell function

Menu item "2.4":

Function	Extended photo cell function
"0"	<ul style="list-style-type: none"> No action
"1" Cancel automatic closing	<ul style="list-style-type: none"> The door closes 3 seconds after the interruption period for the light beam has ended
"2" Vessel recognition	<ul style="list-style-type: none"> The door closes after the interruption period for the light beam has ended, if the interruption period is longer than 1.5 seconds Reset of automatic closing if the interruption duration for the light beam is equal to or less than 1.5 seconds

X7: Input pull switch/radio receiver

Connection of a pull switch or external radio receiver via the terminals X7/1 and X7/2. The switching contact must be potential-free (NO contact).

Pull switch or radio receiver function

Menu item "2.6":

Pulse type	Reaction upon activation
„1“	<ul style="list-style-type: none">• Door is in OPEN final limit position or respectively in intermediate open position: The door CLOSES• From all other door positions or door movements: The door OPENS
„2“	<ul style="list-style-type: none">• OPEN-STOP-CLOSE-STOP-OPEN command order
„3“	<ul style="list-style-type: none">• Door always executes OPEN movement

X8: Input, intermediate stop On/Off

Connect a switch to terminals X8/1 and X8/2 to activate and deactivate the intermediate open. The intermediate open position must be programmed via menu item "1.6".

With an OPEN command, the door moves to the stored door position. When the Intermediate open function is deactivated, the door can move back to the OPEN final limit position.

intermediate open function

Menu item "2.9":

Function	Intermediate open
„1“	<ul style="list-style-type: none">• All command inputs
„2“	<ul style="list-style-type: none">• Intermediate open via X7 pull switch• OPEN final limit position via all other control devices
„3“	<ul style="list-style-type: none">• Intermediate open via external control devices X5 and OPEN push button of the control• OPEN final limit position via all other control devices

! Note!

- Double command with functions „2“ and „3“: Priority is given to OPEN final limit position, independent of command sequence

Potential-free X20 relay contact

The relay functions are described under menu item "2.7".

Attention – Damage to components!

- Maximum current of 1 A at 230 VAC and 0.4 A at 24 VDC
- We recommend the use of LED lamps
- When using light bulbs, these should have power of maximum 40 W and be shock-proof

Force monitoring (DES only)

WARNING

Do not disconnect photoeyes or other safety devices. **Serious injury or death may result from the use of this door with no safety devices.**

Menu item "3.1":

The force monitoring can only be used with fully balanced doors and drive units with DES. It should be able to detect when persons are moving with the door.



Warning!

- The force monitoring is no substitute for safety measures in providing protection against the trapping hazard

Function	Force monitoring
"0"	<ul style="list-style-type: none">• Off
"2" - "1.0"	<ul style="list-style-type: none">• "2": Low limit value• "1.0": High limit value



Important!

- Force monitoring for doors with spring balance only
- Environmental factors such as changes in temperature or wind load can lead to inadvertent triggering of force monitoring

After exiting programming, the door must carry out a full OPEN and CLOSE-operation in self-hold mode.

The force monitoring is a self-learning system which is effective for an opening width range of 5 cm to 2 m (approx.). Slow progressive changes, e.g. gradual reduction of the spring torsion, are compensated automatically.

After force monitoring has been triggered, only the "Hold-to-run" door operating mode is possible and the "F4.1" fault indication is displayed. The resetting occurs when a final limit position for the door is reached.

Maintenance cycle counter

Menu item "8.5":

A value between 0 and 99,000, as a multiple of 1000, can be selected for the maintenance cycle setting.

The maintenance cycle counter reading is reduced by one each time the Open final limit position is reached.

Once the maintenance cycle reaches zero, the setting from menu item "8.6" is activated.

Short-circuit/overload display

If there is a short circuit or an overload of the 24 VDC supply voltage, the 7-digit display vanishes.

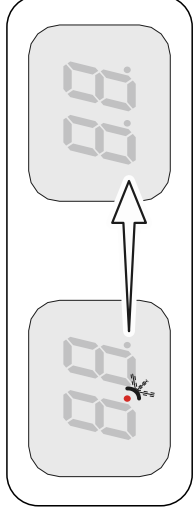

Standby function

If there is no fault or command pending, the control switches to "Standby".

If the automatic closing duration is longer than 60 seconds, the control also switches to "Standby"

Only the left dot is lit up.

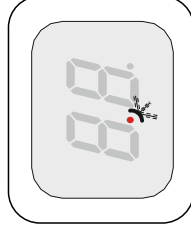

The "Standby" function is terminated with a command or by activation of the selector switch "S".

11 Status display

Faults		
F.	Display: "F" and digit	
Code	Fault description	Fault causes and fault correction
1.2	Terminals X2.1 – X2.2 are open. Stack-rope switch/Pass-door contact is open.	Check door safety switch. Check whether the connection cable is connected.
1.3	Open safety circuit (DES) Emergency manual operation has been activated. Thermal protection of the motor has tripped.	Check emergency manual operation. Check for overload or stalling of the drive unit.
1.4	Terminals X3.1 – X3.2 are open. Emergency stop has been activated.	Check emergency stop. Check whether the connection cable is connected.
1.7	Faulty entrysense switch. Contact resistances are too high. Faulty entrysense installation.	Open and close pass door. Check resistance. Check the pass door installation.
1.8	Entrysense input X2.1 – X2.2 is faulty.	Switch control off and on. Replace control if necessary.
2.0	No safety edge detected.	Check the wiring of the safety edge.
2.1	Terminals X6.1 – X6.2 are open. Photo cell has been activated.	Check alignment of the photo cell. Check connection cable. Replace photo cell if necessary.
2.2	Maximum number of reversing for door through safety edge system activation has been reached. (Only with automatic closing)	Obstacles along the door travel path. Check whether the safety edge is correctly functioning.

Faults

F.	Display: "F" and digit	Fault description	Fault causes and fault correction
Code		Fault description	Fault causes and fault correction
2.4		Activation of safety edge 8k2.	Check whether the safety edge is correctly functioning. Check whether the connection cable has a short circuit.
2.5		Safety edge 8k2 defective.	Check whether the safety edge is correctly functioning. Check whether the connection cable is connected.
2.6		Activation of safety edge 1k2.	Check whether the safety edge is correctly functioning. Check whether the connection cable is connected.
2.7		Safety edge 1k2 defective.	Check whether the safety edge is correctly functioning. Check whether the connection cable has a short circuit.
2.8		1k2 testing is negative.	Testing is activated in the lower final limit position. Check pre-limit switch (with NES "S5").
2.9		Optical safety edge system has been activated or is defective.	Check whether the safety edge is correctly functioning.
3.1		(DES) OPEN emergency limit switch reached. (NES) OPEN or CLOSE emergency limit switch reached. Emergency manual operation has been activated. Thermal protection of the motor has tripped Limit switch system has changed over from NES to DES without the control being reset.	In the voltage-free state, move the door back via emergency manual operation. Check OPEN/CLOSE emergency limit switch. Check emergency manual operation. Check drive unit for overload or stalling. Reset of control via menu item "9.5".
3.2		(DES) CLOSE emergency stop switch reached.	In the voltage-free state, move the door back via emergency manual operation.
3.4		(NES) Faulty activation of the "S5" pre-limit switch.	Check the "S5" pre-limit switch for correct functioning and setting.

















Faults		
F.	Display: "F" and digit	
Code	Fault description	Fault causes and fault correction
35	No limit switch detected (active at initial operation).	Connect the limit switch to the control. Check the limit-switch connection cable.
36	Limit switch system has changed over from DES to NES without the control being reset.	Reset of control via menu item "9.5".
37	Internal plausibility error.	Execute fault clearance through movement command.
41	Triggering of force monitoring.	Check the door mechanism for stiffness.
45	Crash switch X2.1 – X2.2 is activated.	Check crash switch / connection cable. To reset fault: Press STOP-button and hold for 3 seconds.
46	Terminals X6.1 – X6.2 are open. Light curtain has been activated.	Check light curtain. Check whether the connection cable is connected.
47	Light curtain defective.	Comply with the light curtain manufacturer's specifications. Check connection cable.
50	Fault of the controller.	Switch control off and on. Replace control if necessary.
51	ROM error.	Switch control off and on. Replace control if necessary.
52	CPU error.	Switch control off and on. Replace control if necessary.

Faults		
Display: "F" and digit		
Code	Fault description	Fault causes and fault correction
F. 5.3	RAM error.	Switch control off and on. Replace control if necessary.
F. 5.4	Internal fault of control.	Switch control off and on. Replace control if necessary.
F. 5.5	Fault of digital limit switch (DES).	Check DES connector and connection cable. Switch control off and on.
F. 5.6	Fault with door movement.	Check the door mechanism for stiffness. Check limit switch turn. Switch control off and on.
F. 5.7	Fault with rotating direction.	Change rotating direction via menu item "0.2".
F. 5.8	Unacceptable door movement in stopped state.	Execute fault clearance trough movement command. Check brake and drive unit.
F. 5.9	No compliance with open direction at drive unit.	Execute fault clearance trough movement command. Check for overload of the drive.
F. 6.1	DI / FI closing speed is too high.	Switch control off and on. Replace drive unit if necessary.
F. 6.2	Internal FI communication fault.	Switch control off and on. Replace FI-drive unit if necessary.
F. 6.3	Low voltage in the DC voltage sink.	Execute fault clearance trough movement command. Check mains input voltage. Change slope times/speed.













Faults		
Display: "F" and digit		
Code	Fault description	Fault causes and fault correction
F.4	Excess voltage in the DC voltage link.	Check mains input voltage. Execute fault clearance trough movement command. Change slope times/speed.
F.5	Temperature limit exceeded.	Check for overload of the drive unit. Cool down the drive unit and reduce the number of cycles.
F.6	Permanent current overload.	Check for overload of the drive unit. Check the door mechanism for stiffness or weight.
F.7	Brake / FI fault.	Check brake; replace if necessary. If problem recurs, replace drive unit.
F.9	Collective indication for FI.	Execute fault clearance trough movement command. Replace drive unit if message continues to be displayed.
F.1	At initial operation minimum travel distance was not completed.	Move the door for at least 1 second.









Commands	
Display: "E" and code	Command description
	An Open command is present. Inputs X5.3, X7.2, UBS control device or UBS radio receiver.
	A STOP command is present. Inputs X5.2, X7.2, UBS control device or UBS radio receiver or simultaneous Open and Close command.
	A CLOSE command is present. Inputs X5.4, X7.2, UBS control device or UBS radio receiver.

Status indications

Status display	Description
	Preset value for maintenance cycle counter reached.
	Dot on left is not lit: Control circuit has a short circuit or is overloaded.
	Function for changing the rotating direction is activated, only possible during initial operation.
	Change of rotating direction has been carried out, only possible during initial operation.
	Programming option is blocked.
Flashing 	Teach in OPEN final limit position.
Flashing 	Teach in CLOSE final limit position.
Flashing 	UPWARDS travel active.
Flashing 	CLOSING operation active.
Flashing 	Stop between the set final limit positions.
Flashing 	Stop at the OPEN final limit position.
Flashing 	Stop at the intermediate stop position.
Flashing 	Stop at the CLOSE final limit position.
Flashing 	Blocking of programming option confirmed. Flashing display: Unblocking of programming option active.
Flashing 	Interruption of the photo cell function: At first interruption of the light beam.
Flashing 	Interruption of the photo cell function: When exiting the programming.

12 Explanation of symbols

Symbol	Explanation
	Prompt: Read installation instructions
	Prompt: Check
	Prompt: Note
	Prompt: Note the setting of the menu below
	Factory setting of the menu
	Factory setting of the menu, value on the right
	Factory setting of the minimum limit, dependent on drive unit
	Factory setting of the maximum limit, dependent on drive unit
	Setting range
	Prompt: Select menu item or value, turn selector switch to the left or to the right
	Prompt: View menu item, press selector switch once
	Prompt: Store, press selector switch once

Symbol	Explanation
	<p>Prompt: Setting via OPEN/CLOSE built in push-button; Use OPEN push-button to increase value, CLOSE push-button to decrease value</p>
	<p>Prompt: Press stop button once via built in push-button</p>
	<p>Prompt: Save, press stop button once via built in push-button</p>
	<p>Prompt: Save, press stop button for three seconds via built in push-button</p>
	<p>Prompt: Reset the control, press stop button for three seconds via built in push-button</p>
	<p>Prompt: Move to door position</p>
	<p>Prompt: Move to door position for OPEN final limit position</p>
	<p>Prompt: Move to pre-limit</p>
	<p>Prompt: Move to door position for CLOSE final limit position</p>

APPENDIX B - REFERENCE WIRING

REFERENCE WIRING

The following section shows wiring information for your motor. This is for reference only. All of these connections will be made at the factory. Do not adjust any of the following connections unless directed to do so by technical services.

THREE PHASE 230VAC OPERATORS WITH HALF WAVE BRAKE RECTIFIERS

These models use 810273.0001 wiring kit, 102/130VDC brake.

810271.0001 SI25.14

810257.0001 SI40.14

810258.0001 SI80.14

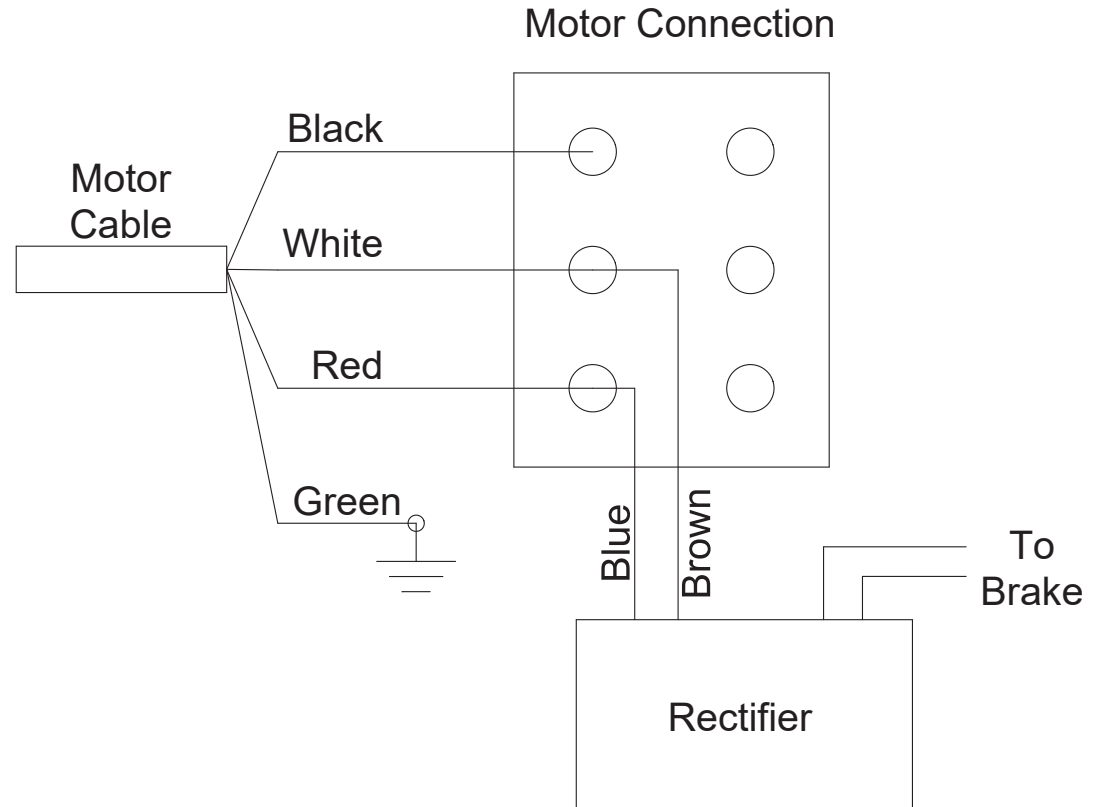

APPENDIX B - REFERENCE WIRING

SINGLE PHASE 220VAC OPERATORS

This model uses 810273.0002 wiring kit, no brake.
500277.0001 SI45.15

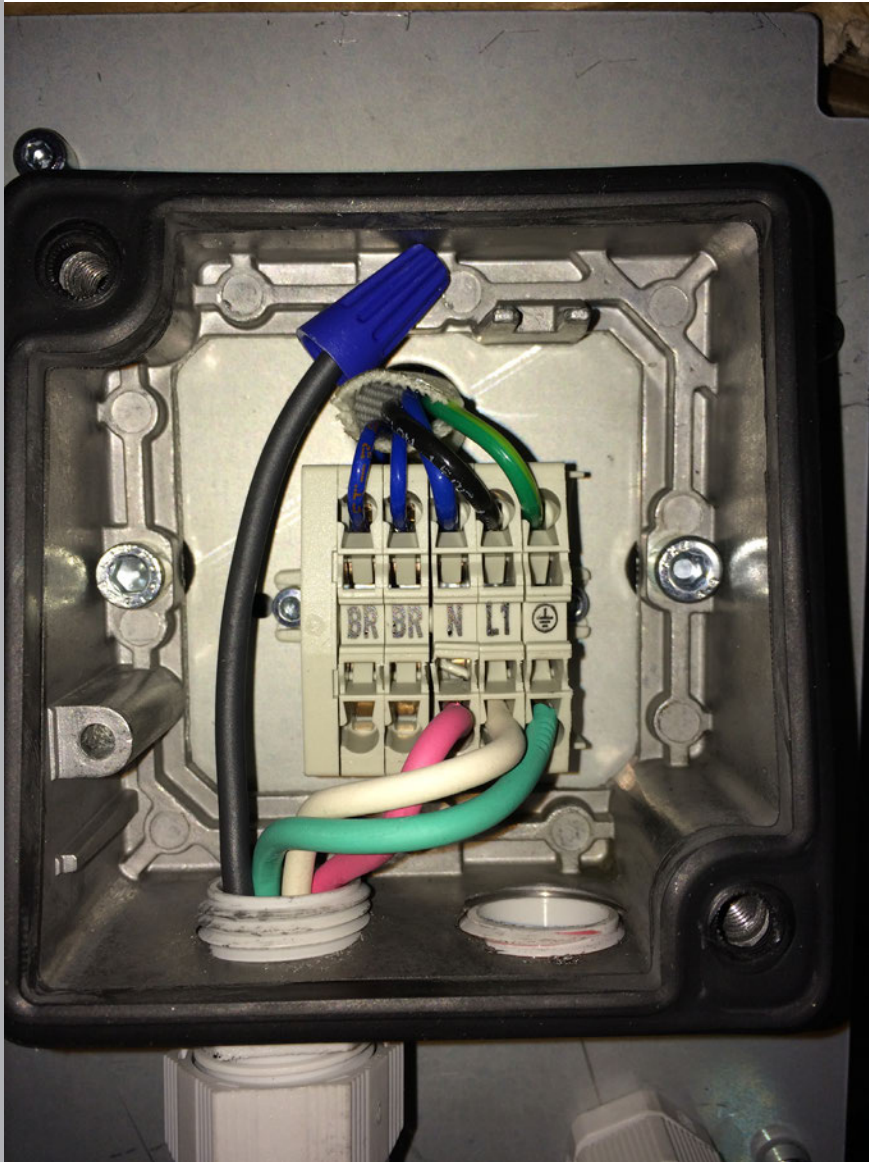

Motor Connection

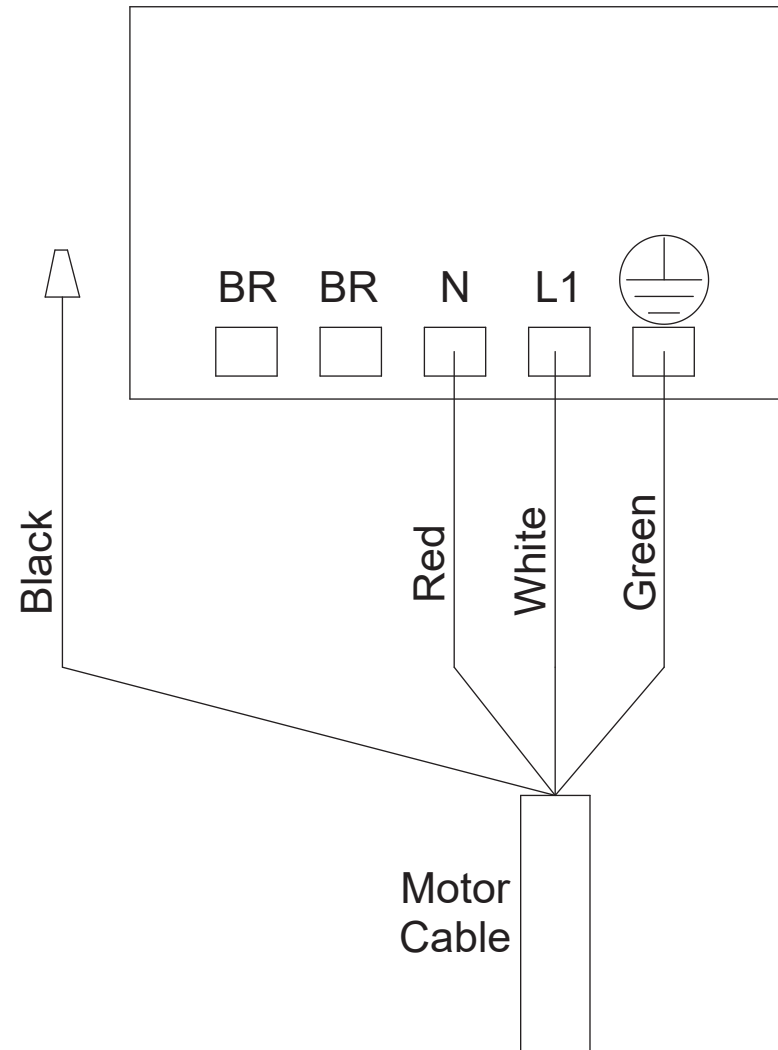

APPENDIX B - REFERENCE WIRING

THREE PHASE 230VAC OPERATORS WITH FULL WAVE BRAKE RECTIFIERS

These models use 810273.0001 wiring kit, 178/205VDC brake.
 810277.0001 SI25.14 with rectifier strap
 810278.0001 SI40.14 with rectifier strap

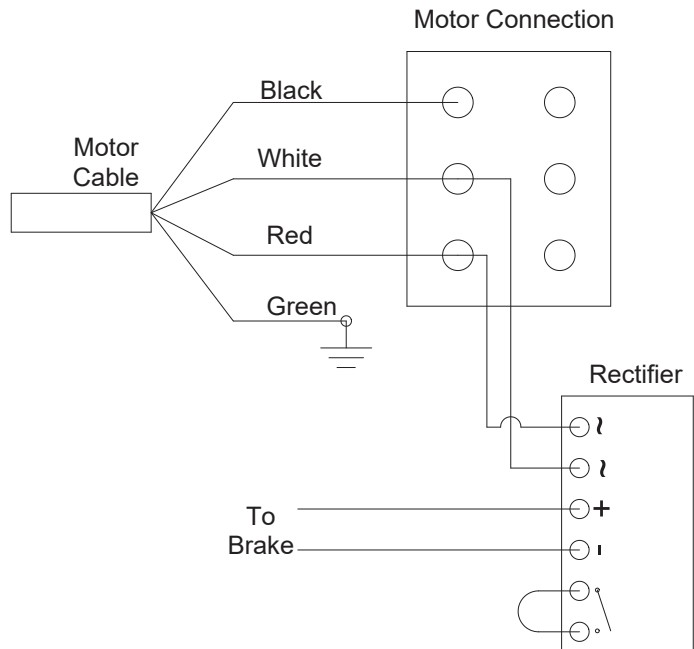
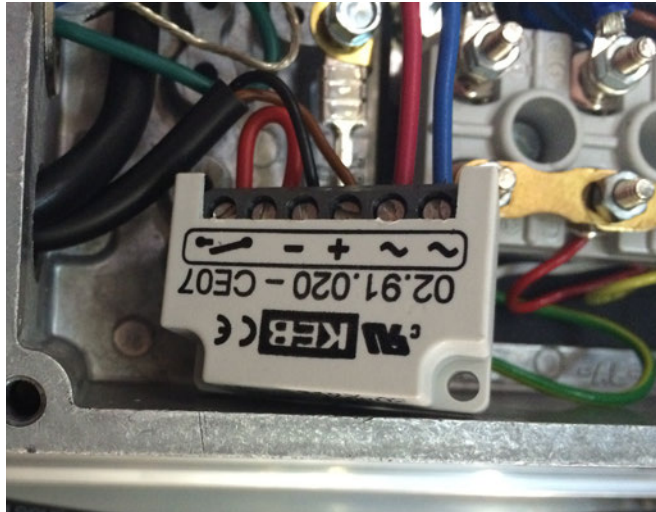

This model uses 810273.0003 wiring kit, 178/205VDC brake.
 810279.0001 SI80.14 with rectifier control

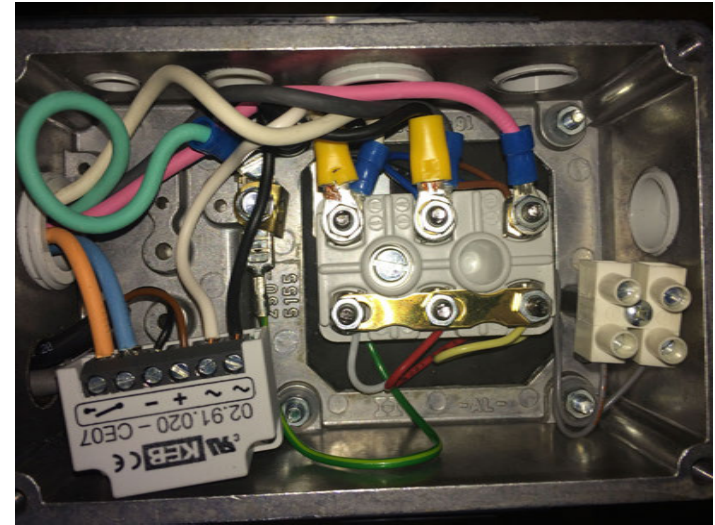

THREE PHASE WITH RECTIFIER CONTROL

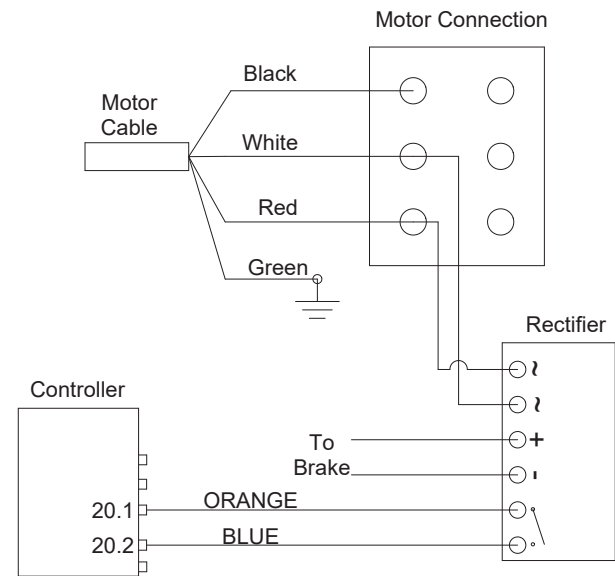

APPENDIX C - POWER CONSUMPTION OF ACCESSORIES

600 HC Actuators and Signaling Equipment List with Amp Draw	Part Number	24VDC Current Draw
		180mA MAX onboard capacity
Photo Sensor Assembly	Part Number	Amp Draw
Commercial photocell set (comes standard with door system)	810187.0001 (LH) 810187.0002 (RH)	125mA
Extra set of commercial photo cells (must be factory installed)	810187.0001 (LH) 810187.0002 (RH)	125mA; requires external power supply
Sensing Edge (coiled)	Part Number	Amp Draw
Monitored Electric Sensing Edge (ASO) (2 wire universal)	500276.0001	3mA
Interior Push-Buttons	Part Number	Amp Draw
3-Button (OPEN/CLOSE/STOP), Surface or Flush Mount	075211.0000.S	3mA
3-Button (OPEN/CLOSE/STOP), Flush Mount, With Keyed Lockout	110319.0001.S	3mA
3-Button (OPEN/CLOSE/STOP), Exterior Surface Mount, Stainless Steel NEMA 4X Enclosure	110335.0001.S	3mA
Exterior Push-Buttons	Part Number	Amp Draw
1-Button Mushroom Head, Exterior Surface Mount	110322.0001.S	3mA
3-Button (OPEN/CLOSE/STOP), Surface Mount, Non Metallic	075394.0000.S	3mA
3-Button (OPEN/CLOSE/STOP), Surface Mount, Non Metallic, With Keyed Lockout	110314.0001.S	3mA
Interior Key Switches	Part Number	Amp Draw
Open/Close, Flush Mount, Tamper Proof, Interior	107042.0003.S	3mA
Open/Close, With Stop Button, Flush Mount, Tamper Proof, Interior	107042.0004.S	3mA
Exterior Key Switches	Part Number	Amp Draw
Open/Close, Surface Mount, Tamper Proof, Exterior	107041.0003.S	3mA
Open/Close, With Stop Button, Surface Mount, Tamper Proof, Exterior	107041.0004.S	3mA
Signaling Equipment (not available on the 2HP motor; used on larger doors; consult factory with questions.)	Part Number	Amp Draw
Rotating Warning Light, Red, Weather Proof 120 VAC	110348.0001.S	requires external power supply
ADA Approved Horn/Strobe Combination, 24 VDC, In Weatherproof Gang Box	110351.0001.S	66-210mA; requires external power supply
Loop Equipment	Part Number	Amp Draw
Loop Detector, 10/30 VDC/VAC loop detector with harness	820720.0000	100mA; requires external power supply
Motion Detectors	Part Number	Amp Draw
Falcon XL, High Performance for Doors 6' to 11' high (NEMA 4)	810145.0002.S	10mA
Falcon, High Performance for Doors 11' to 24' high (NEMA 4)	810145.0001.S	10mA
Radio Controls	Part Number	Amp Draw
390 MHz Fixed Code 3 wire fixed code; 9 switch trinary	34564R	30mA; may require external power supply based on options selected
Intellicode® Dual Frequency Receiver (Stores 7 transmitters) For use with Genie Master remote	36240R	30mA; may require external power supply based on options selected

APPENDIX D - OPTIONAL WIRED SAFETY EDGE

NOTE: The controller is only capable of accepting one monitored safety device. By default the standard photoeyes are the monitored device. The optional wired safety edge will be non-monitored.

SAFETY EDGE WIRING

STEP 1: Install the provided junction box and arm to the guide on the motor side. The junction box should be attached at the guide bolt closest to the center of the door height.

STEP 2: Install coil cord from the guide junction box to the safety edge.

STEP 3: Wire the junction box to the controller according to the diagram below.

NOTE: Reference controller diagram on page 25 to locate X2 plug.

NOTE: Refer to pages 42-46 for setup of the safety edge.

